

High-speed and High-precision Linear Power Supply

IT6400 Series User Manual



Model: IT6411/IT6431/IT6432/IT6433/IT6411S

Version: V2.4

Statement

© Itech Electronic, Co., Ltd. 2019
No part of this manual may be reproduced in any form or by any means (including electronic storage and retrieval or translation into a foreign language) without prior permission and written consent from Itech Electronic, Co., Ltd. as governed by international copyright laws.

Manual Article No.

IT6400-402458

Revision

Revision 2, published on

June 11, 2019

Itech Electronic, Co., Ltd.

Trademark Statement

Pentium is a registered trademark of Intel Corporation in the United States.

Microsoft, Visual Studio, Windows and MS Windows are trademarks of Microsoft Corporation in the United States and/or other countries/regions.

Guarantee

Materials in the document are provided *talis qualis* and may be changed in future revisions without prior notice. In addition, within the maximum allowable extent of laws, ITECH is not committed to any explicit or implied guarantee for this manual and all information therein, including but not limited to the implied guarantee on marketability and availability for some special purposes. ITECH shall not be responsible for any error or incidental or indirect losses caused by the provision, use or application of this documents and information therein. If some guarantee clauses in other written agreements between ITECH and users are not consistent with clauses herein, those clauses in other written agreements shall prevail.

Technology license

Hardware and/or software in this document cannot be provided without a license and can only be used or copied according to the license.

Restricted permission statement

Restricted permissions of the U.S. government. Permissions for software and technical data which are authorized to the U.S. Government only include those for custom provision to end users. ITECH follows FAR 12.211 (technical data), 12.212 (computer software). DFARS 252.227-7015 (technical data--commercial products) for national defense and DFARS 227.7202-3 (permissions for commercial computer software or computer software documents) while providing the customized business licenses of software and technical data.

Safety Statement

CAUTION

“Caution” signs indicate danger. It is required to pay attention to the contents of these signs during implementation of operations.

The damage to the product or loss of important data may be caused in case of improper operation steps or failure to follow operation steps. Do not continue to implement any improper operation indicated in “Caution” signs when the specified conditions are not fully understood or these conditions are not satisfied.

WARNING

“Warning” indicates danger. It is required to pay attention to the contents of these signs during implementation of operation steps. Personal casualties may be caused in case of improper operation steps or failure to follow these operation steps. Do not continue to implement any improper operation indicated in “Warning” signs when the specified conditions are not fully understood or these conditions are not satisfied.



Note

“Instructions” indicates operation instructions. It is required to refer to the contents of these signs during operation steps. These signs are used for providing tips or supplementary information for operators.

Certification and Quality Assurance

IT6400 series power supply completely reaches nominal technical indicators in the manual.

Warranty service

ITECH Company will provide one-year warranty services for the product materials and manufacturing (excluding the following limitations).











- When warranty service or repair is needed, please send the product to the service unit specified by ITECH Company.
- When the product is sent to ITECH Company for warranty service, the customer must pay the one-way freight to the maintenance department of ITECH, and ITECH will be responsible for return freight.
- If the product is sent to ITECH for warranty service from other countries, the customer will be responsible for all the freight, duties and other taxes.

Limitation of Warranty

This Warranty will be rendered invalid in case of the following:

- Damage caused by circuit installed by customer or using customer own products or accessories;
- Product which has been modified or repaired by the customer;
- Damage caused by circuit installed by customer or not operating our products under designated environment;
- The product model or serial number is altered, deleted, removed or made illegible by customer;
- Damage caused by accidents, including but not limited to lightning, water, fire, abuse or negligence.

Safety signs

	Direct current		ON (power on)
	Alternating current	○	OFF (power off)
	Both direct and alternating current		Power-on state
	Protective conductor terminal		Power-off state
	Earth (ground) terminal		Reference terminal
	Caution, risk of electric shock	+	Positive terminal
	Warning, risk of danger (refer to this manual for specific Warning or Caution information)	-	Negative terminal
	Frame or chassis terminal	-	-

Safety Precautions

General safety precautions below must be followed in each phase of instrument operation. In case of failure to follow these precautions or specific warnings in other parts of the manual, violation against the safety standards related to the design, manufacture and purpose of the instrument will occur. If the user does not follow these precautions, ITECH will bear no responsibility arising there from.

WARNING

- The power supply is provided with a three-core power cord during delivery and should be connected to a three-core junction box. Before operation, be sure that the power supply is well grounded.
- Use electric wires of appropriate load. All loading wires should be capable of bearing maximum short-circuit of electronic load without overheating.
- Ensure the voltage fluctuation of mains supply is less than 10% of the working voltage range in order to reduce risks of fire and electric shock.
- To prevent burnout, please pay special attention to positive and negative polarities of power supply during connection!
- Do not use damaged equipment. Please check the housing before using the equipment. Check whether the instrument is subject to cracking or is lack of plastic. Do not operate the instrument in the environment with explosive gas, steam or dust.
- Observe all tags on the equipment before connection.
- Do not install alternative parts on the instrument or perform any unauthorized modification.
- Do not use the equipment when the removable cover is dismantled or loose.
- Please use the power adapter supplied by the manufacturer to avoid accidental injury.
- We do not accept responsibility for any direct or indirect financial damage or loss of profit that might occur when using the instrument.
- This instrument is used for industrial purposes. Do not apply this product to IT power supply system.
- Do not use the equipment on the life support system or other equipment with safety requirements.

CAUTION

- If the equipment is not used in the manner specified by the manufacturer, its protection may be damaged.
- Always use dry cloth to clean the equipment housing. Do not clean the inside of the instrument.
- Do not block the air vent of the equipment.

Environmental conditions

The IT6400 series power supply can only be used indoors or in low condensation areas. The following table shows general environmental

requirements for this instrument.



Environmental conditions	Requirement
Operating temperature	0°C - 40°C
Operating humidity	20% - 80% (non condensing)
Storage temperature	-20°C - 70 °C
Altitude	Operating up to 2,000 meters
Pollution	Grade 2 pollution
Installation category	II



Note

To make accurate measurements, allow the instrument to warm up for 30 min before operation.

Regulation tag

	<p>The CE mark indicates that the product complies with all the relevant European legal directives. The specific year (if any) affixed refers to the year when the design was approved.</p>
	<p>The instrument complies with the WEEE Directive (2002/96/EC) marking requirement. This affixed product label indicates that you must not discard the electrical/electronic product in domestic household waste.</p>
	<p>This symbol indicates the time period during which no hazardous or toxic substances are expected to leak or deteriorate during normal use. The expected service life of the product is 10 years. The product can be used safely during the 10-year Environment Friendly Use Period (EFUP). Upon expiration of the EFUP, the product must be immediately recycled.</p>

Waste electrical and electronic equipment (WEEE) directive



Waste electrical and electronic equipment (WEEE) directive, 2002/96/EC

The product complies with tag requirements of the WEEE directive (2002/96/EC). This tag indicates that the electronic equipment cannot be disposed of as ordinary household waste.

Product Category

According to the equipment classification in Annex I of the WEEE directive, this instrument belongs to the "Monitoring" product.

If you want to return the unnecessary instrument, please contact the nearest sales office of ITECH.

Compliance Information

Complies with the essential requirements of the following applicable European Directives, and carries the CE marking accordingly:

- Electromagnetic Compatibility (EMC) Directive 2014/30/EU
- Low-Voltage Directive (Safety) 2014/35/EU

Conforms with the following product standards:

EMC Standard

IEC 61326-1:2012/ EN 61326-1:2013 ¹²³

Reference Standards

CISPR 11:2009+A1:2010/ EN 55011:2009+A1:2010 (Group 1, Class A)

IEC 61000-4-2:2008/ EN 61000-4-2:2009

IEC 61000-4-3:2006+A1:2007+A2:2010/ EN 61000-4-3:2006+A1:2008+A2:2010

IEC 61000-4-4:2004+A1:2010/ EN 61000-4-4:2004+A1:2010

IEC 61000-4-5:2005/ EN 61000-4-5:2006

IEC 61000-4-6:2008/ EN 61000-4-6:2009

IEC 61000-4-11:2004/ EN 61000-4-11:2004

1. The product is intended for use in non-residential/non-domestic environments. Use of the product in residential/domestic environments may cause electromagnetic interference.
2. Connection of the instrument to a test object may produce radiations beyond the specified limit.
3. Use high-performance shielded interface cable to ensure conformity with the EMC standards listed above.

Safety Standard

IEC 61010-1:2010/ EN 61010-1:2010

Content

Certification and Quality Assurance	I
Warranty service	I
Limitation of Warranty	I
Safety signs.....	I
Safety Precautions.....	II
Environmental conditions	II
Regulation tag	III
Waste electrical and electronic equipment (WEEE) directive	III
Compliance Information	IV
Chapter1 Inspection and Installation	1
1.1 Verifying the Shipment.....	1
1.2 Instrument Size Introduction	2
1.3 Rack Mounting	3
1.4 Connecting the Power Cord	3
1.5 DUT Connection	4
Chapter2 Quick Start	8
2.1 Brief Introduction	8
2.2 Introduction of Front Panel	9
2.3 Introduction of Keyboard	9
2.4 Introduction of Interface Display Information	10
2.5 Introduction of Interface Symbols.....	11
2.6 Introduction of Rear Panel	12
2.7 Power-on Self-Test	13
Chapter3 Basic Operation	16
3.1 Local/Remote Operation Mode Switching	16
3.2 Output On/Off Control	16
3.3 System Menu Function (System).....	16
3.4 Config Menu Function (Config)	17
3.5 Math Menu Function (Math)	19
3.6 Key Lock Function.....	20
3.7 Screen Capture Function	20
3.8 Save/Recall Operation	20
3.9 Triggering Function	21
3.10 Protection Function.....	22
3.11 Digital Quantity Control Interface	25
3.12 Series Operation.....	27
Chapter4 Power Supply Function.....	29
4.1 Basic Concepts	29
4.2 Setting of Measurement Function and Interface Display.....	32
4.3 Setting of Output Parameters	32
4.4 Setting of Filter.....	33
Chapter5 Waveform Display Function.....	35
5.1 Basic Concepts	35
5.2 Setting of Knob Functions	37
5.3 Horizontal Control and Vertical Control	39
5.4 Setting of Trigger Configuration	40
Chapter6 Battery Simulation Function	42
6.1 Basic Concepts	42
6.2 Battery Charging Function.....	45
6.3 Battery Discharging Function	45
6.4 Battery Characteristic Simulation.....	46

Chapter7	List Function	53
7.1	Basic Concepts	53
7.2	List Operation.....	55
Chapter8	Routine Maintenance	60
8.1	Error Information References.....	60
8.2	Daily maintenance.....	60
8.3	Contact of ITECH Engineers.....	61
8.4	Returning Your Power for Service	62
Chapter9	Technical Specification	63
Chapter10	Remote Operation Mode.....	74
10.1	USB Interface.....	74
10.2	GPIB Interface	74
10.3	LAN Interface.....	74
Appendix.....		75
	Specifications of Red and Black Test Lines	75

Chapter1 Inspection and Installation

1.1 Verifying the Shipment

Unpack the box and check the contents before operating the instrument. If wrong items have been delivered, if items are missing, or if there is a defect with the appearance of the items, contact the dealer from which you purchased the instrument immediately. The package contents include:

Table 1-1 Checklist of Package Contents

Item	Qty.	Model	Remarks
IT6400 series power supply	x1	IT6400 series	IT6400 series include: IT6411/IT6431/IT6432/IT6433/IT6411S
Power cord	x1	IT-E171/IT-E172/IT-E173/IT-E174	User may select an appropriate power cord that matches the specifications of power socket used in the area. See the Section 1.4 Connecting the Power Cord for details.
USB cable	x1	-	-
CD	x1	-	It contains IT6400 series power supply Installation Instruction, User's Manual, Programming Guide and other user documentations.
Ex-factory Test Report	x1	-	It is the test report of the instrument before delivery.



NOTE

Upon verification of the shipment, keep the package and relevant contents thereof in a safe place. When returning the instrument for warranty service or repair, the specified packing requirements shall be met. Refer to IT6400 User's Manual for detailed requirements on returns.

IT6400 series power supply is supplied with the following optional accessories (sold separately):

Item	Model	Remarks
Rack mount kit	IT-E151/ IT-E151A	To mount the instrument on a special rack, user may select this optional.

1.2 Instrument Size Introduction

The instrument should be installed at well-ventilated and rational-sized space.
Please select appropriate space for installation based on the power supply size.

IT6411/IT6431/IT6432/IT6433/IT6411S model

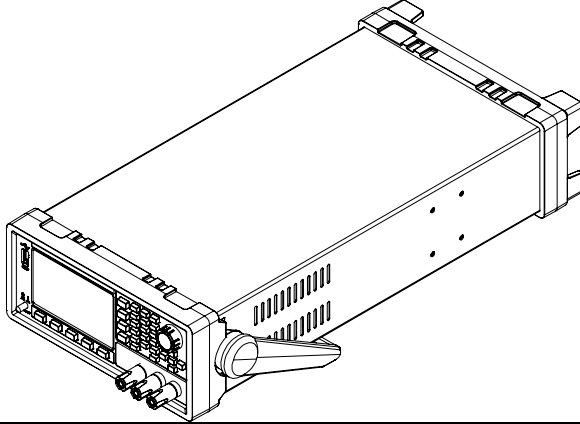

Detailed Dimension Drawing

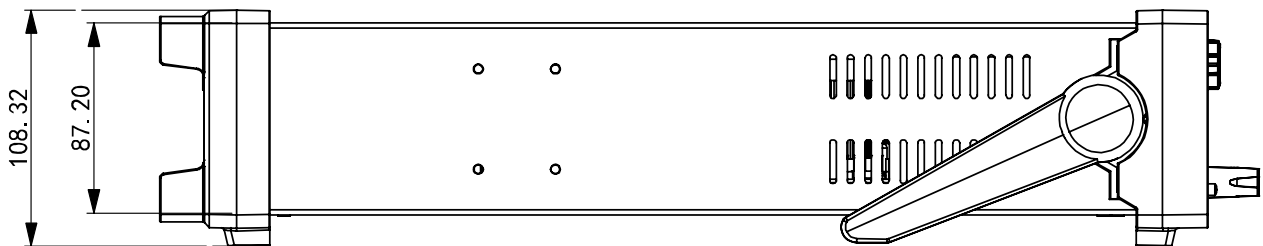
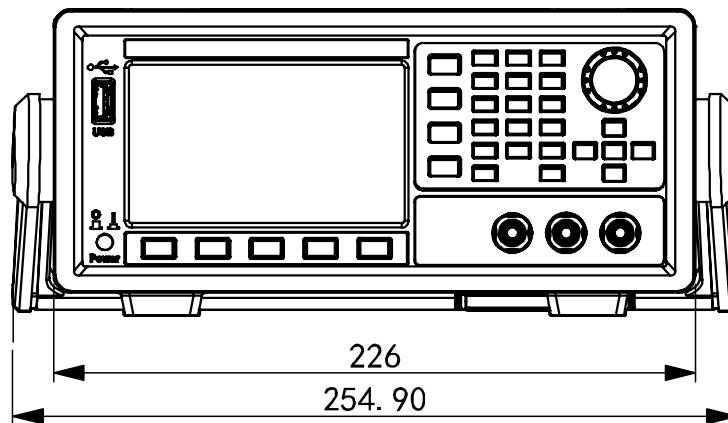

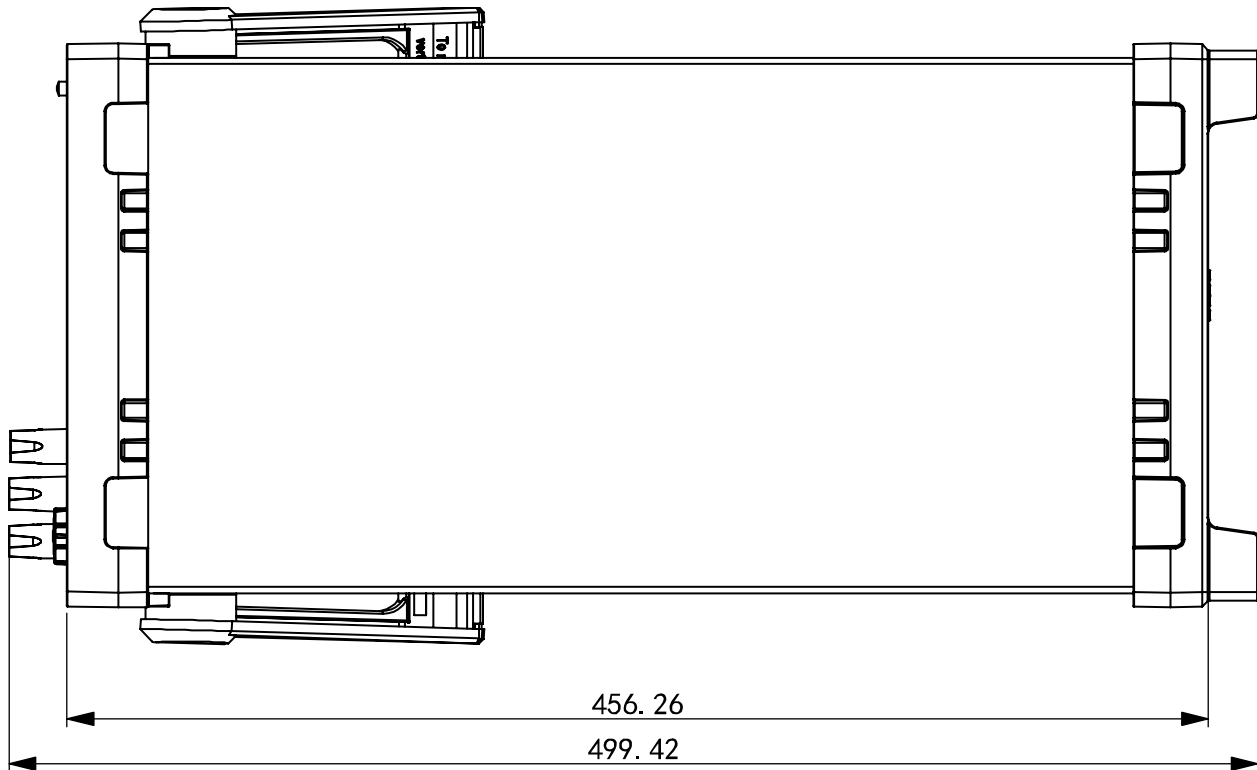

1.3 Rack Mounting

IT6400 series power supply can be mounted on a standard 19" rack. ITECH provides user with IT-E151/IT-E151A rack, an optional mount kit. The detailed operation please refer to the User Manual of your mount kit.

1.4 Connecting the Power Cord

Connect power line of standard accessories and ensure that the power is under normal power supply.

AC power input level

Working voltage of IT6400 series power supply includes 110V and 220V (which can be selected by the switch at the bottom of load).

AC power input level:

- Option Opt.01: 220VAC \pm 10%, 47 to 63 Hz
- Option Opt.02: 110 VAC \pm 10%, 47 to 63 Hz

Categories of power lines

Select from the following schedule of power cord specifications an appropriate power cord that matches the voltage for the area in which you use the instrument. If the power cord included in the instrument you purchased does not match the voltage, contact the dealer or manufacturer for change.

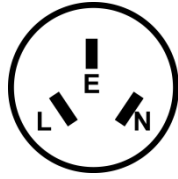

China
IT-171



America, Canada,
Japan
IT-E172

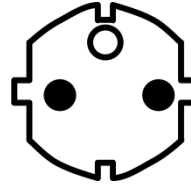

Europe
IT-E173

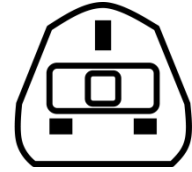

Britain
IT-E174

Connecting the power cord

Before connecting the power cord, please ensure the power switch of the instrument is turned OFF. Only use the power cord supplied as a standard accessory. A summary of connection procedures is given below.

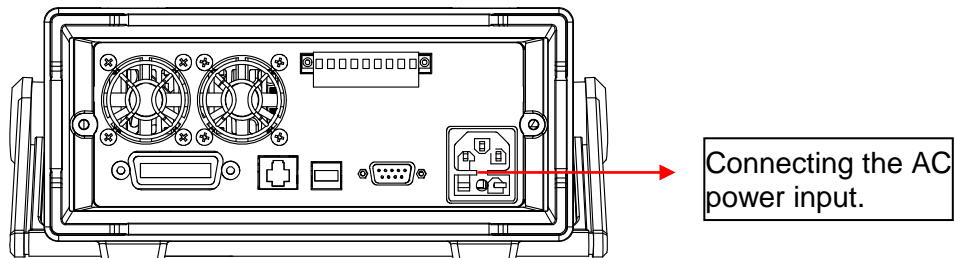

1.5 DUT Connection

This section introduces how to connect the Device under Test (DUT) to the IT6400 series power supply output terminal.

Pre-connection Notes

WARNING

- Please switch off the power output when connecting the output circuit in order to avoid electric shock.
- Ensure that the main power supply plug is accessed to the power socket with protective grounding. Never use the wiring board without protective grounding. Before circuit connection, be sure that the power supply is well grounded.
- When measuring the cable insulating layer, ensure that the wires (bare wires) connected to the output terminals are not exposed. At the same time, fix the screws of output terminals and ensure that the connected cables will not fall off from the output terminal.
- Before change of connection, set the channel output as OFF. Otherwise, the DUT may be damaged.

Schematic Diagram of S+/S- and +/- Rear Panel:

When the DUT consumes high current, voltage drop will appear at the connecting wire between the power supply and the DUT terminals. To ensure measurement accuracy, a remote measurement terminal is provided at the rear

panel of the power supply, from which, the User may measure the input terminal voltage of the DUT.

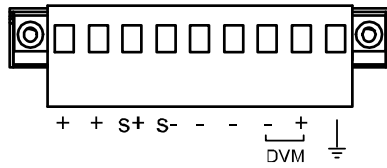

- S+/S-: Remote measurement terminal: when remote measurement function is applied, lead out the “S+ and S-” for connecting the DUT.
- +/-: Output terminal.

Use local measurement:

The local measurement does not compensate the voltage drop on the wires. The operations are as follows:

1. Use the shorting clip on the rear panel or directly install wires between + and S+ as well as - and S-.
2. Connect the output of positive and negative terminals on the front panel or the + and - terminals on the rear panel to the DUT through wires.

Wiring Schematic Diagram of Local Measurement is as follows:

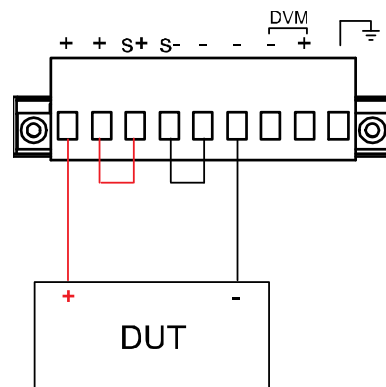

Use remote measurement:

The remote measurement function allows compensation for voltage drop of the electric wires between the power supply output terminal and the DUT.

Operations are as follows:

1. Remove any wire jumpers or shorting clips between the + and S+ as well as between the - and S- of the terminal board connector on the rear panel.
2. Connect one pair of induction wires from the S+ and S- to the DUT.
3. Connect one pair of drive wires from the positive and negative terminals on the front panel or the + and - terminals on the rear panel to the DUT.

Wiring Schematic Diagram of Remote Measurement is as follows:

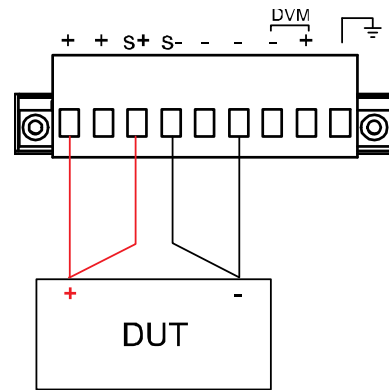
NOTE

To ensure system stability, please apply armored twisted-pair cables between the IT6400 series power supply remote measurement and DUT. Do not twist the sense connection wires and the load wires. To prevent damage, please pay special attention to positive and negative polarities of power supply during connection! When the remote measurement function is not used, do not leave the Sense terminal suspended!

Use of capacitor in circuit:

If capacitor is used in circuit, the installation position should be as shown below:

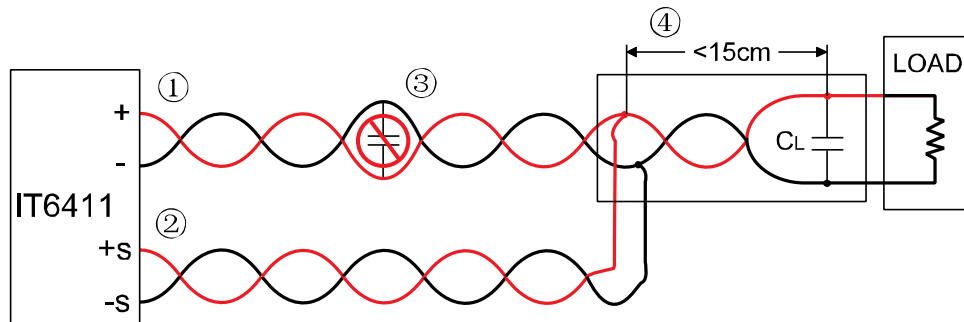

- ① Load wires must be twisted-pair or coax and must not be twisted with the sense wires.
- ② Sense wires must be twisted-pair or coax and must not be twisted with the load wires.
- ③ No capacitors are allowed within the sense-compensated load path.
- ④ If the load capacitor (C_L) is not located at the sense point, the distance from the sense point to the load capacitor cannot exceed 15cm and must be twisted-pair, coax, or pc traces.

Connection of DVM

IT6400 series power supply is built in with a digital voltmeter (DVM), which can be used for measuring external voltage.

DVM measurement wiring is as follows:

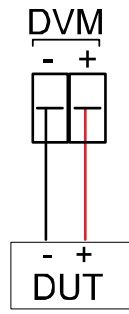

Chapter2 Quick Start

2.1 Brief Introduction

IT6411/IT6431/IT6432/IT6433/IT6411S programmable DC power supply is a kind of IT6400 Series high-speed and high-precision linear DC power supply with a single channel. The battery simulating function is especially applicable for development and high speed production testing of portable, battery-operated products, such as smart phones and wireless chipsets, Bluetooth headsets, tablet computers, digital cameras, GPS receivers, RFIC power amplifiers, and intelligence wearing, etc. Ultrafast transient time and new designed speed shift mode achieves voltage/current high speed rising waveform without overshoot. Meanwhile, IT6400 series have the function of waveform display, let the test be visible and simple.

Features

- Accurate Battery Simulation
- Oscilloscope waveform display (DSO)
- Ultrafast transient response time
- Ultrafast Voltage rising time
- Built-in high accuracy DVM
- Variable output impedance
- Relay out function achieves electrical isolation on terminals
- List function achieves voltage/current output as programmed
- Standard interface LAN/USB/GPIB
- Applicable to portable battery power supplies test
- LED test no overcharged current

Model	Voltage	Current	Power
IT6411	±15V/±9V	±3A/±5A	45W
IT6411S	±15V	±0.1A	1.5W
IT6431	±15V	±10A	150W
IT6432	±30V	±5A	150W
IT6433	±60V	±2.5A	150W

2.2 Introduction of Front Panel

Schematic Diagram of Front Panel of IT6400 series Power Supply and Function Keys.

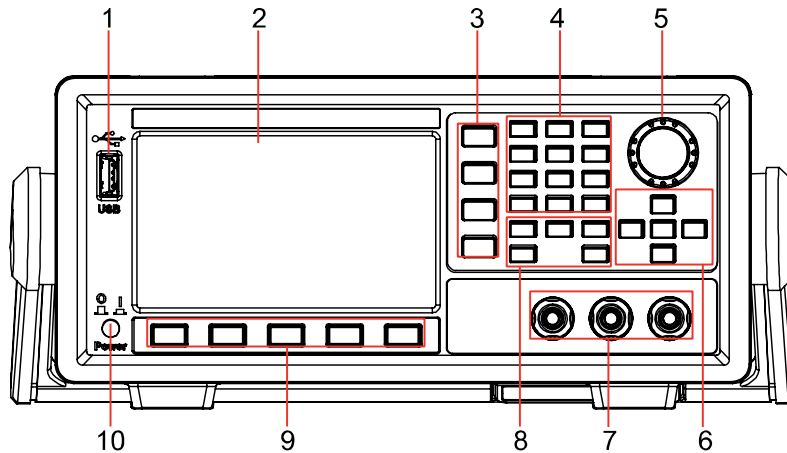



- | | |
|--------------------|---|
| 1 USB interface | 2 Display |
| 3 Menu key | 4 Numeric key, Decimal point and “±”key |
| 5 Rotary knob | 6 Arrow keys and Enter key |
| 7 Output terminals | 8 Function key |
| 9 Menu key | 10 Power switch |

2.3 Introduction of Keyboard

The functions of keys on the front panel of the IT6400 series power supply are shown in the following table.

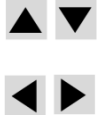
Key tag	Name and function
Home	Home key, used for canceling the present interface and switching to the Source interface.
Menu	Menu key, used for canceling current interface and switching to the Power-on Menu.
Trig	Trigger key, used for triggering set status or modes.
Esc	Esc key, used for canceling current setting or exiting current setting interface.
On/Off	Output switches, used for switching the output status of power supply.
OK	Enter key, used for saving the settings.
0-9	Numeric key, Enter the number directly.

Key tag	Name and function
	Up/Down key and Left/Right key Menu Edit: the programming items can be rolled by operating the Up/Down key. Prompts of corresponding options are displayed on the right and options can be selected through the soft key. Digit Edit: the programming items can be rolled by operating the Up/Down key. The digit to be edited is selected by operating the Left/Right key or through the knob. Carrying can be completed automatically.
	Soft key The contents on the left of the key and the menu function displayed above the key on the display screen may be subject to changes.
	Knob key, used for setting the value indicated by the cursor, selecting the voltage and current range, adjusting the waveform, etc.

2.4 Introduction of Interface Display Information

Home interface

After IT6400 series power supply is turned on, the power supply function interface is displayed as follows.

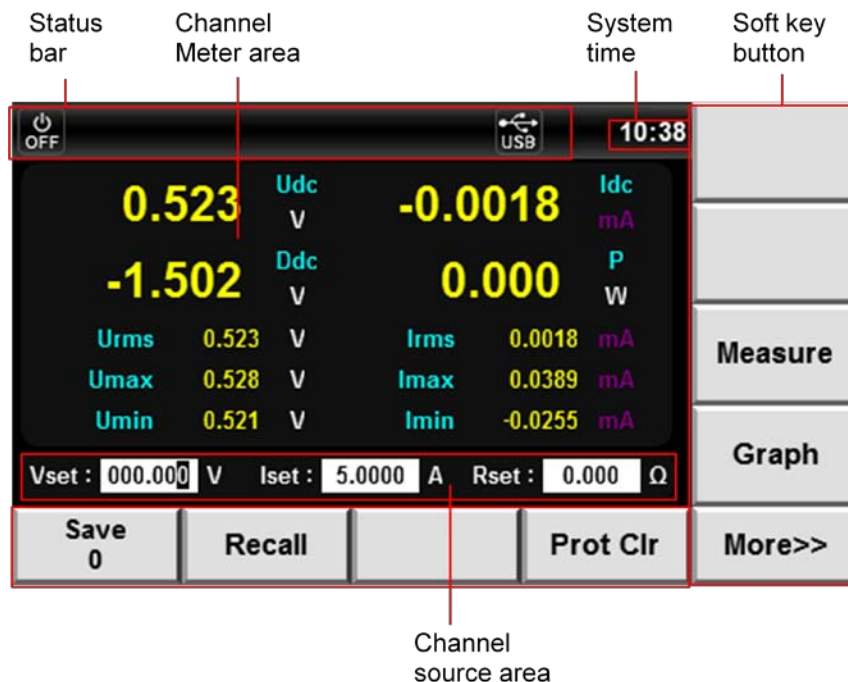

Menu configuration interface

Press the **[Menu]** soft key to enter the Menu configuration interface which comprises 7 functional icons. You can select these functional icons by the arrow keys or knob and press OK to confirm. The Menu configuration interface is shown as follows

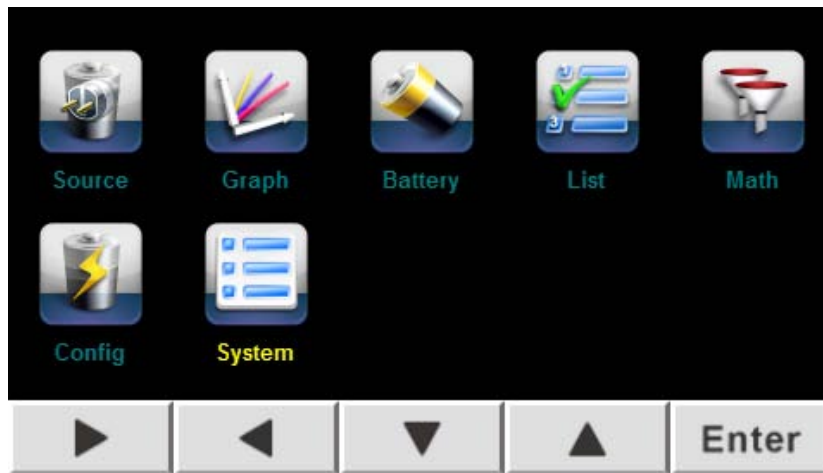













Function description of options:

Option	Function description
Source	Source function, used for setting voltage, current and internal resistance of the power supply. The display is same as the Home key.
Graph	Waveform display function, used for setting display wave curve and corresponding current and voltage.
Battery	Battery function, used for battery charging/discharging and characteristic simulation.
List	List, used for setting and editing output steps, output voltage and corresponding time.
Math	Used for selecting the filtering type of power supply output, storage depth and type synthesis.
Config	Power supply configuration menu, comprising Speed, Range, OVP, Limit, etc.
System	System menu, comprising Sys Log, Sys Conf, Sys Info, Sys Comm, Sys Cal, etc.

2.5 Introduction of Interface Symbols

IT6400 series Power Supply interface will show the following symbols and icons.

Status Bar icon	Status description
	This icon appears when USB is inserted.
	This icon appears when over-voltage protection function is switched on.
	This icon appears when over-current protection function is switched on.
	Over-voltage protection icon: this icon appears when over-voltage occurs.

Status Bar icon	Status description
	Over-current protection icon: this icon appears when over-current occurs.
	Over-temperature protection icon: this icon appears when over-temperature occurs.
	This icon appears in remote network connection.
	Key Lock: this icon appears when the keyboard is locked.
	Output is off.
	The Power is under constant current mode.
	The Power is under constant voltage mode.
	List icon: this icon appears when the LIST in run.
	This icon appears when reverse polarity is found on the output terminal or when the voltage loaded on the output terminal is 120% of the rated voltage.

2.6 Introduction of Rear Panel

Schematic Diagram of Rear Panel of IT6411/IT6411S Power Supply.

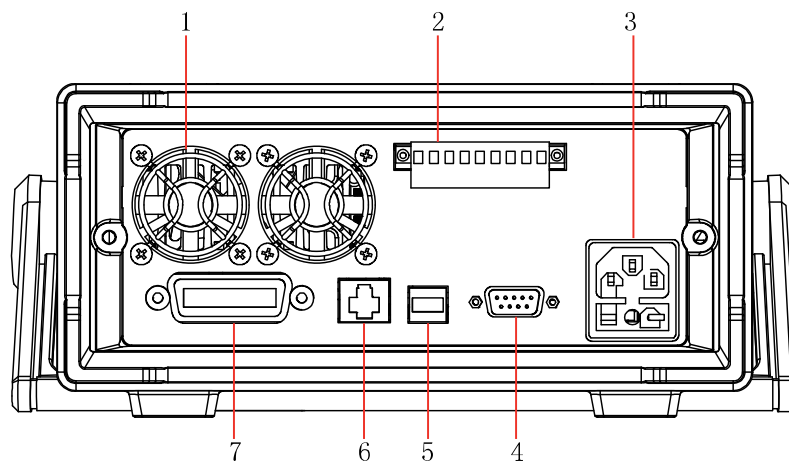

- 1 Vent hole
- 2 Remote sense terminal, the output terminal and DVM terminal
- 3 AC power input socket
- 4 SYSTEM I/O terminal
- 5 USB communication interface
- 6 LAN communication interface
- 7 GPIB communication interface

Schematic Diagram of Rear Panel of IT6431/IT6432/IT6433 Power Supply.

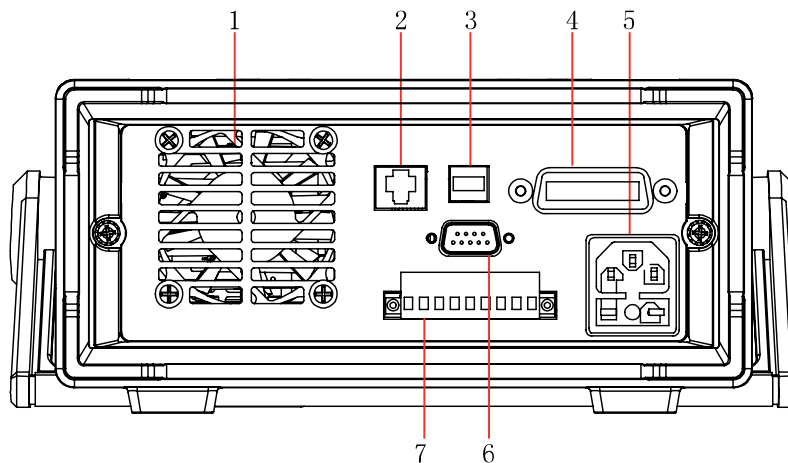

- 1 Vent hole
- 2 LAN communication interface
- 3 USB communication interface
- 4 GPIB communication interface
- 5 AC power input socket
- 6 SYSTEM I/O terminal
- 7 Remote sense terminal, the output terminal and DVM terminal

2.7 Power-on Self-Test

A power-on self-test is a process performed by the instrument to confirm that the instrument purchased by user meets our delivery standards and can function properly during normal use. Before operation, make sure you've read carefully and understand all the general safety precautions contained in the manual.

WARNING

- To prevent burn-out, be sure to confirm that the power supply voltage is consistent with the service voltage before power-on.
- Ensure that the main power supply plug is accessed to the power socket with protective grounding. Never use the wiring board without protective grounding. Before operation, be sure that the power supply is well grounded.
- To prevent burn-out, pay attention to maximum current/voltage limits before wiring.

The normal self-test procedures are shown as follows:

1. Correctly connect the power cord and press the **Power** key to power on.
2. After start-up, the display screen will be shown as follows.

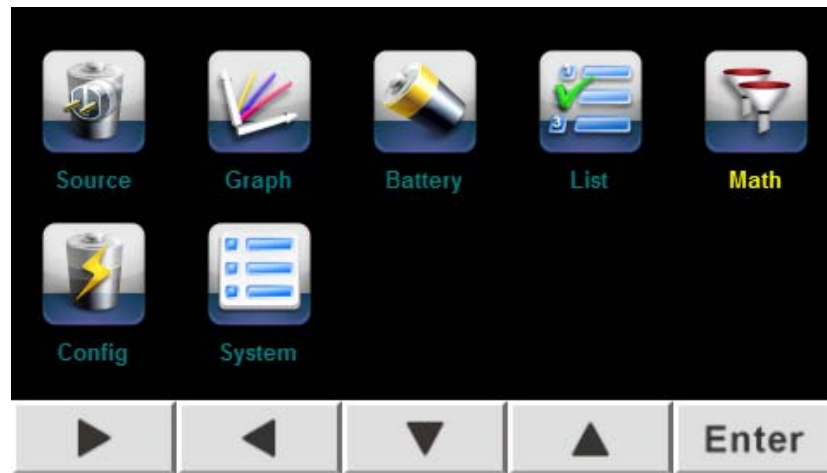

3. Select “System” to enter the System Menu Configuration interface. Press the **[Sys Info]** key to enter the Instrument System Information interface to view the product model, serial number and software version number.

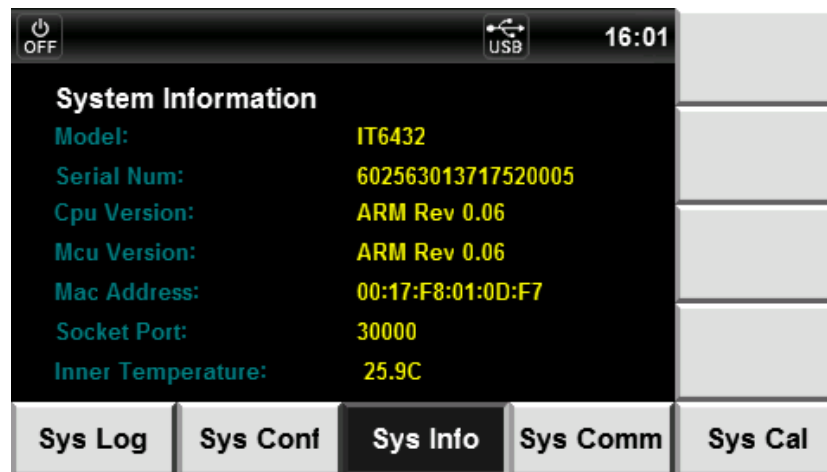

4. In the System Menu setting interface, press the **[Sys Conf]** key to enter the System Configuration Information.



5. Press the Up/Down key to select “System SelfTest” and press the **[Run]** soft key at right to start self-test. After self-test, enter the Home interface.



NOTE

In case of any errors during Self-test, stop self-test and contact ITECH Sales Agent or Technical Service Engineer.

Replacing the Fuse

During normal use of the instrument, you need to replace the fuse if it's burnt out according to the following procedures:

1. First pull out the power cord, and then take out the fuse block from the power cord jack with a small screwdriver, as shown below:

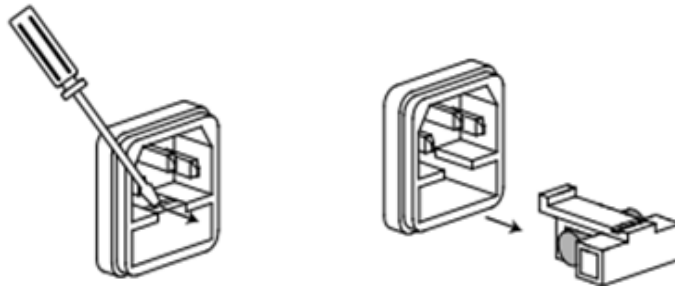

2. Have a visual inspection of the fuse to see whether it is burnt out; if yes, replace it with another fuse of the same specification, for detailed specification, please refer to the **chapter Specification**.
3. After replacement, mount the fuse block to the original position, as illustrated below:

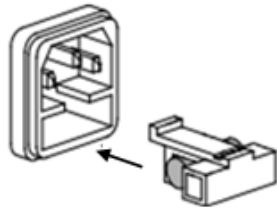

Chapter3 Basic Operation

This Chapter introduces related operations for keys on the front panel of IT6400 series power supply. When the keys on the front panel are used for operation, the power supply should be under local operation mode, under which, the User can perform all functions of the power supply through the front panel keys. The power supply is defaulted under local operation mode at initialization.

3.1 Local/Remote Operation Mode Switching

The power provides local and remote operation modes. These two modes can be switched through communication commands. At initialization, the default value is local operation mode.

- **Local operation mode:** for operating related functions through keys on the instrument.
- **Remote operation mode:** for operating related functions through the PC connected to the power supply. When the power supply is under the remote operation mode, except Print key, other keys on the panel are disabled. By sending SYSTem:LOCal command, switch to local operation mode. The output parameters of the power supply are not affected by change of the operation modes.

3.2 Output On/Off Control

Press the **[On/Off]** key on the front panel of power supply to control output switches of power supply. When the **[On/Off]** key is lighted on, the output is switched on; and when the **[On/Off]** key is lighted off, the output is switched off. When the power supply is on, the working state icon (CV/CC) on the LCD will be lighted on.



Note

To avoid wiring sparking, press the **[On/Off]** key to switch on output after connection of the power supply and the DUT. If there is no output after it is switched on, check the voltage/current set value. Please set the voltage and current values as non-zero before switching on the output again.

3.3 System Menu Function (System)

Select “Menu > System” to enter the System Menu interface. The menu is described as follows:

System	System menu configuration	
System Calibration	System Cal	
	Calibration unit (only used in factory)	
	Voltage Cal	Voltage Calibration
	Current Cal	Current Calibration
	RES Cal	Resistance Calibration
	DVM Cal	DVM Calibration
System	System Comm	Communication configuration

Communication	USB	Type B Connect	Select the USB communication interface.
	GPIB	GPIB Address	The address is adjustable between 1 and 30.
	LAN	IP Mode	IP mode: MANU/DHCP.
		IP Address	IP address setting.
		Subnet Mask	Set the subnet mask.
	Gateway	Set the gateway.	
System Information	System Information		Instrument system information
	Model	Instrument model	
	Serial Num	Instrument SN	
	Cpu Version	The version of Cpu	
	Mcu Version	The version of Mcu	
	Mac Address	Network hardware address	
	Socket Port	Port number	
	Inner Temperature	Instrument temperature	
System Config	System Config		System Configuration
	Date(YY/MM/DD)	System date: Year/Month/Day	
	Time(hh/mm/ss)	System time: Hour/Minute/Second	
	Brightness	Set the screen brightness.	
	Beep	Set the keyboard sound	
	System Reset	System Reset	
	System SelfTest	System SelfTest	
	System Protection Clear	Clear protection status and output latch status	
Sys Log	System Log		System Log information
	Please Insert USB Device!	Please insert the USB peripheral device. After insertion, all operations will be recorded in the USB.	

3.4 Config Menu Function (Config)

Select "Menu > Config" to enter the System Menu interface. The menu is described as follows:

Config	Configuration menu setting		
Conf1	Source Config		Source Configuration
	Output Speed:	Configure the output speed: Fast or Normal	
	Voltage Range:	Configure voltage output range: High or Low	
	Current Sense:	Configure current sense: High or Auto	
	OVP(V):	Configure over-voltage protection	
	Voltage Limit(V):	Configure voltage output limit	

	Current Limit(A):	Configure current output limit
	Output Delay(s)	Configure output delay
Conf2	Source Config	Source configuration information
	Output-off States:	Configure the Output-off state: High Impedance, Normal, Zero, Relay off
	OCP State:	Configure over-current protection: ON or OFF
	Trace State:	This function is not available in IT6411/IT6431/IT6432/IT6433/IT6411S power supply.
	Trigger Mode:	Configure trigger mode: Internal (Manual trigger), Bus (Command trigger) or External (External signal trigger)
	Ext_ON/OFF State:	Configure external On/Off control state: ON or OFF
	Ext_ON/OFF Mode:	Configure external On/Off control mode: Latch or Live
	Digital Function	Digital function selection: RIDFi (power fault indication mode) or DIGio (common digital I/O interface)
Conf3	Calibration Zero	Calibration zero
	Current Low Range	Set small current zero calibration: On (turn the zero calibration function on), Off (turn the zero calibration function off), Cal (when the zero calibration function is turned on, operate the small current zero calibration)

Configuring the Output Speed

This option is used for configuring the output speed. The maximum output speed under Normal mode is 5ms. If a higher speed is required, switch to the Fast mode, under which, 500us is available at maximum. Under Time mode, it is used for setting the time of voltage rise speed of power supply output.

Configuring Voltage Range

This option is used for configuring the voltage output range: High and Low.

IT6411 power supply has two output ranges for switchover: High and Low. The current range changes with the voltage range.

IT6431/IT6432/IT6433/IT6411S output power supply has only a single range - High range for usage. As shown below.

Model	Voltage range	Voltage output range
IT6411	High	-15.1V ~ +15.1V
		Current output range: -3.05A ~ +3.05A
	Low	-9.05V ~ +9.05V
		Current output range: -5.05A ~ +5.05A
IT6411S	High	-15.1V ~ +15.1V
		Current output range: -0.1A ~ +0.1A
IT6431	High	-15.1V ~ +15.1V

		Current output range: -10.05A ~ +10.05A
IT6432	High	-30.1V ~ +30.1V
		Current output range: -5.05A ~ +5.05A
IT6433	High	-60.1V ~ +60.1V
		Current output range: -2.55A ~ +2.55A

Configuring Current Sense

This option is used for configuring current sense: High and Auto. Take IT6411s as example, when Auto is configured, switch to Low mode when current is lower than 100uA. The measurement precision is 0.05%+50nA and resolution ratio 1nA.

Configuring Output-off State

This item is used to set the status after the power output is turned off. Select Menu > Config > Conf2 to enter configuration menu interface. Press up or down keys to select Output-off, and then press [High Impedance], [Normal], [Zero] or [Relay off] soft keys on the right side to set the output off status.

- Select High Impedance. After the power output is turned off, the output terminals of the power supply can be seen as a DC impedance (100k to 400k). The impedance values of different models are different.
- Select Normal. After the power output is turned off, if the output voltage is 0V, the output current is 0.05% of the output rated value.
- Select Zero. After the power output is turned off, if the output voltage is 0V, the current setting value keeps the value when the output was turned on.
- Select Relay off. After the power output is turned off, use the relay to disconnect the internal circuit and external load. The isolation impedance is over 1 GΩ.

3.5 Math Menu Function (Math)

Select “Menu > Math” to enter the Math Menu interface. The menu is described as follows:

Math	Math menu configuration	
Filter	Filter	Filter configuration
	Filter State:	Configure the filter state: ON or OFF
	Filter Type:	Configure the filter algorithm type: Average filtering (Average) Hanning filtering (Hanning) Rectangle filtering (Rectangle)
	Sample Rate	Sample rate: 30KHZ at maximum
	Sample Count:	Sample count: 600 points at maximum
Buffer	Buffer	Buffer configuration
	Buffer Size:	Buffer size: (1~ 1,024)
	Buffer Statistics:	Statistics: Mean Peak, Max and Min
	Buffer Mode:	Buffer control mode: Always (FIFO), Next (Repetition), Never (OFF)
	Auto Clear:	Automatic clear when full: ON or OFF





	Clear: Immediately	Yes: Manually clear the buffer.
	Export To USB:	Export to the USB (Buffer_xx.txt)

Configure buffer



The buffer will collect the measurement results and data till full. The collected data comprise voltage and current measurement data. The User can configure the following parameters for buffer functions:

- **Buffer Size:** Buffer size. Maximum buffer size of power supply will be 1,024 pcs of data.
- **Buffer Statistics:** Statistics option. If the data are to be saved in the buffer, the statistic data can be calculated, like: Mean, Peak, Max and Min
- **Buffer Mode:** Save control mode. Including Always (FIFO, first in and first out of data in the buffer area), Next (Repetition, enable write protection till the buffer area is full) and Never (OFF, disable write protection for the buffer area).
- **Auto Clear:** Auto clear the buffer. ON or OFF
- **Clear: Immediately:** Manually clear the buffer.
- **Export To USB:** Export the buffer data to the USB (Buffer_xx.txt)

3.6 Key Lock Function

Press  and the left key  on the front board at the same time to lock the keys on the front board. At this time, the LCD displays  icon. Under this functional state, except the Print key, other keys are disabled. Press the  and the left key  again to unlock.

3.7 Screen Capture Function

The power supply is provided with screen shot function. Press the right key  and the  key, the power supply will shot the present screen and save it to peripheral memory disk.

3.8 Save/Recall Operation

The power supply can save some common parameters in 50 groups of nonvolatile memories (NVM) for convenient and fast access by the User, comprising: voltage set value, current set value and resistance set value. The soft keys **[Save]** and **[Recall]** or SCPI commands *SAV and *RCL can be used for access operation in the save area.

Save operation:

1. Select "Menu > Source" to enter the Power Supply Function interface.
2. Set up parameters like voltage, current and resistance. For example, 3V, 0.5A and 0Ω (For details, refer to 4.3 Setting of Output Parameters).
3. Press the **[Save]** soft key to save the set parameters in the save position

displayed in present Save successively. In this case, the parameters are saved in Save0.

- Set up the parameters of Group 2, for example: 2V, 1A and 0.1Ω.

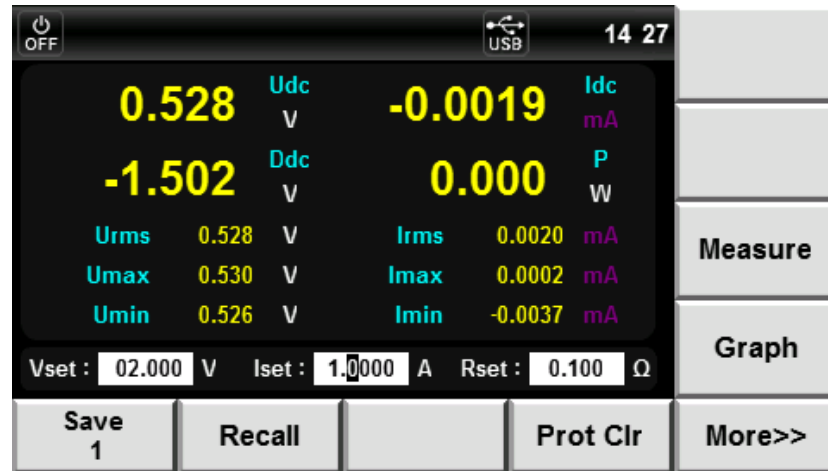

- Press the **[Save]** soft key to save the set parameters in Save1.

Recall operation:

- Select "Menu > Source" to enter the Power Supply Function interface.
- Press the **[Recall]** soft key to enter the Recall interface.
- Use the ▲ ▼ key to select the recalled group (blue font background).



- Press the **[Ok]** soft key to confirm the recalled group.
- Press the **[Esc]** soft key to return to the Power Supply Function interface.

3.9 Triggering Function

IT6400 series power supply can be triggered by means of: manual trigger (Internal), command trigger (BUS) and external signal trigger (External).

- Manual trigger (Internal):** When Manual Trigger mode is valid, press the **[Trig]** key to make one trigger.
- External signal trigger (External):** The DB9 terminals (Pins 1 and 5) on the rear panel of the power supply are input terminal for external signal trigger. When the External Trigger mode is valid, apply one descending

edge from high pulse to low pulse, then the power supply will make one trigger.

- **Command trigger (BUS):** When the Command Trigger mode is valid, the power supply will make one trigger after receipt of the trigger command TRIGger.

Trigger mode is selected as follows:

Operation steps

1. Select “Menu > Config > Conf2” to enter the Configuration Menu Function interface.
2. Press the Up/Down key to select the “Trigger Mode” setting value (purple font background) to enter the Trigger Mode Selection interface.

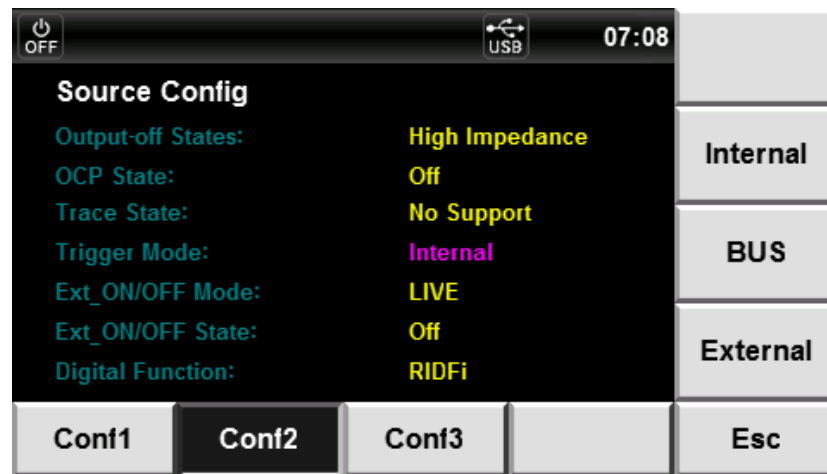

3. Press the right soft key corresponding to this parameter to select the trigger mode. Press the **[OK]** key to complete configuration.

Internal: Manual trigger

BUS: Command trigger

External: External signal trigger

4. Press the **[Esc]** key to exit configuration.

3.10 Protection Function

The power supply is also provided with the following protections: over voltage protection (OVP), over current protection (OCP) and over temperature protection (OTP).

Configure protection function

In IT6400 series power supply, the User can configure the following parameters for OVP and OCP protection functions:

Protection type	State	Upper limit
Over voltage protection (OVP)	On: Switch on protection Off: Switch off protection	Voltage value of OVP
Over current protection (OCP)	On: Switch on protection Off: Switch off protection	-

Taking the OVP as example, detailed configuration steps are as follows:

1. Press the **[Menu]** key to enter the Power Menu Configuration interface.
2. Select “Config > Conf1” to enter the Configuration Menu interface.
3. Press the Up/Down key to move the cursor to the configuration position of OVP functional state, as shown in the figure below:

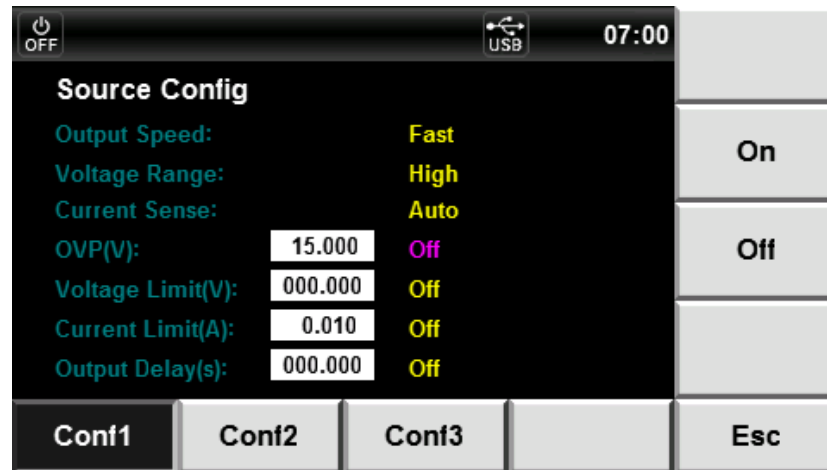

4. Press the corresponding soft key at right to configure the OVP functional state. On: Switch on the OVP function; Off: Switch off the OVP function.
5. Press the Up/Down key to move the cursor to the configuration position of OVP function protection point and directly use the Numeric keys or Left/Right key and knob for adjustment to configure the voltage protection point value.

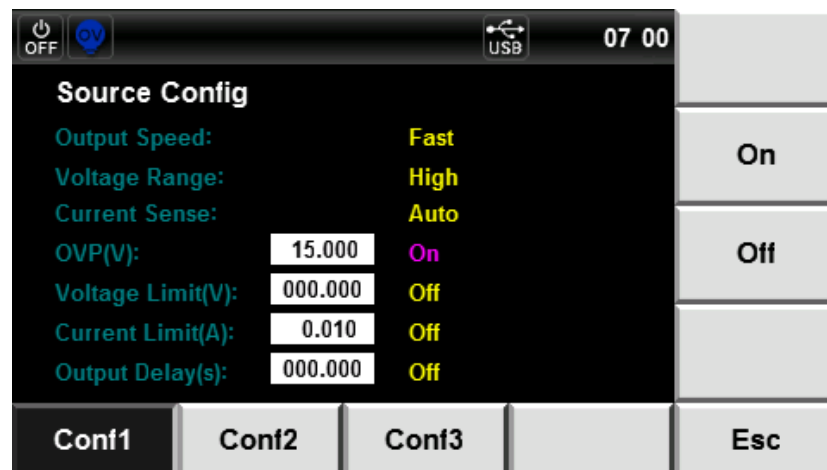

6. If the OVP protection function is on, the  icon is displayed on the display screen.

Over Voltage Protection(OVP)

- **Software over-voltage protection:** when the over-voltage protection is enabled, the voltage at the power output terminal is limited to the value set by the over voltage protection. If the over-voltage protection is triggered, the output will immediately be switched off and the LCD display will show



- **Hardware over-voltage protection:** when the over-voltage protection is disabled, the maximum input voltage of the power supply is limited to about 120% of the present voltage range. If the hardware over-voltage protection is triggered, the output will be immediately switched off and the LCD display will show . To avoid damage to the internal elements of the product, please avoid that the external voltage loaded on the output terminal is over 120% of the rated voltage.
- **Clear OVP:** When the power supply occurs OVP, firstly cut off the DUT. Select “Menu > System > Sys Conf” on the interface to enter the System Menu interface. Select System Protection Clear by the Up/Down Key and press the **[Ok]** soft key to clear OVP. If the power is under remote state, firstly clear the protection state (by sending OUTPut: PROTEction: CLear command) before switching on output through the OUTPut ON.

Over Current Protection (OCP)

- **Over current protection:** the maximum output current of the power supply will be limited to the present current set value (Iset). If OCP is triggered, the OC position in the state register will be configured; and if the OCP is released, the OC position in the state register will be reset.
- **Clear OCP:** When the power supply occurs OCP, firstly cut off the DUT. Select “Menu > System > Sys Conf” on the interface to enter the System Menu interface. Select System Protection Clear by the Up/Down Key and press the **[Ok]** soft key to clear OVP. If the power is under remote state, firstly clear the protection state (by sending OUTPut: PROTEction: CLear command) before switching on output through the OUTPut ON.

Over Temperature Protection (OTP)

- **Over temperature protection:** when the internal power device is over 90°C, the over temperature protection occurs. At this time, the power supply will be automatically OFF and the LCD will display . At the same time, the OT and PS positions in the state register will also be configured and kept till reset.
- **Clear OTP:** When the power supply temperature is lowered to the protection point, select “Menu > System > Sys Conf” on the interface to enter the System Menu interface. Select System Protection Clear by the Up/Down Key and press the **[Ok]** soft key to clear OVP. If the power is under remote state, firstly clear the protection state (by sending OUTPut: PROTEction: CLear command) before switching on output through the OUTPut ON.

Reverse Polarity Protection

- **Reverse polarity protection:** when reverse polarity occurs at the input voltage, the power supply buzzer will sound and the VF position of the status register will be set. The screen will display  and the VF will be kept till reset. Reverse polarity protection will not change the present On/Off status of the power supply.
- **Clear Reverse polarity protection:** check for reverse polarity. If so, cut off the connector and reconnect again. Select “Menu > System > Sys Conf” to enter the System Menu. Select System Protection Clear by the Up/Down Key and press the **[Ok]** soft key on the right to clear the protection status. If

the power is under remote state, send OUTPUT:PROTECTION:CLEAR command to clear the protection status.



Note

Only IT6431/IT6432/IT6433 power supply has the **reverse polarity protection**.

3.11 Digital Quantity Control Interface

The rear panel of IT6400 series power supply has a DB9 digital quantity control interface (SYSTEM I/O), which can be used for controlling and monitoring power supply output. Pins of SYSTEM I/O interface at the rear panel are defined as follows:

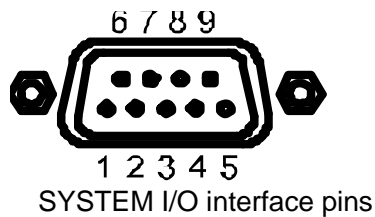



Model	Pin number	Description
IT6411/ IT6411S	1	Ext_Trigger
IT6411/ IT6411S	2	Ext_On/Off
IT6431/ IT6432/ IT6433	3	DIGio1/RIDFi
IT6431/ IT6432/ IT6433	4	DIGio2/RIDFi
IT6411/ IT6411S	5、6、7、8、9	GND
IT6431/ IT6432/ IT6433	5	GND
IT6431/ IT6432/ IT6433	6、7、8、9	No conjunction

Digital function selection:

The level of SYSTEM I/O interface on the rear panel is TTL level. The interface can be divided into the following three functional modes:

- **Trigger function:** Pin 1 can be used as the external trigger terminal of the power supply. For details, refer to 3.9 Triggering Function.
- **Ext On / Off function:** Pin 2 can be used for controlling output state of the power supply.
- **DIGio / RIDFi function:** Pins 3 and 4 are multiple terminals, which can be used as the common digital I/O interfaces and read and control the output terminal state through communication command. Or, they can be used for indicating power supply fault.

When the multiple terminals are used, select the terminal function mode. Refer to the steps below:

1. Press the **[Menu]** key to enter the Menu Configuration page.
2. Select "Config >Conf2" to enter to Configuration Menu interface.
3. Select the "Digital Function" functions by the   key. Press the right soft key corresponding to this parameter to select DIGio or RIDFi mode.

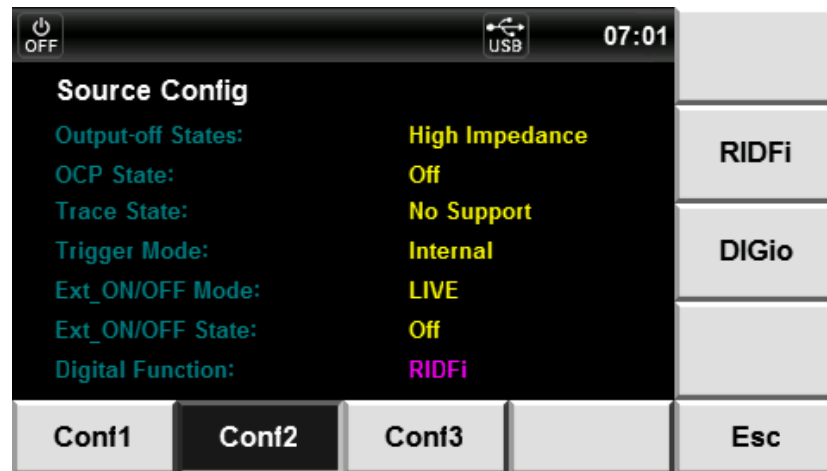

RIDFi: Power fault indication mode



DIGio: Common digital I/O interface mode

4. Press the **[Esc]** key to return.

External On/Off control

The output state of the IT6400 series power supply can be controlled through external TTL level. When the external output control function is on, the On/Off on the front panel of power supply will become invalid and the power supply output state can only be controlled through external TTL.

The User can configure this function in the menu as follows:



1. Press the **[Menu]** key to enter the Menu Configuration page.
2. Select "Config > Conf2" to enter to Configuration Menu interface.
3. Select the "Ext_ON/OFF State" parameters by the  key. Press the right soft key corresponding to this parameter to switch on/off the external output control functions.
 - **ON:** Switch on external control
 - **OFF:** Switch off external control
4. Select the "Ext ON/OFF Mode" parameters by the  key. Press the right soft key corresponding to this parameter to select the external control mode.
 - **Latch:** Latch mode. After the detection of level change (from high to low) at the external On/Off control terminals, the power supply output will be switched off. To release the latch state, send the command (OUTPUT: PROTECTION: CLEAR) or select "Menu > System > Sys Conf" on the interface to enter the System Menu interface. Select the System Protection Clear by the Up/Down key. Press the right **[OK]** soft key to release the latch mode.
 - **Live:** Live mode. The output state of power supply changes with the level of external On/Off control terminal. When the On/Off control terminal input is high-level, the power supply output is on; and when the external On/Off control terminal input is low-level, the power supply output is off.
5. Press the **[Esc]** key to return.

Power fault indication

The EXT RIDFi terminal is provided with power supply fault indication. The terminal sources can be divided into QUES, OPER, ESB, RQS and OFF.



- **QUES:** The EXT RIDFi terminal output level changes with the QUES bit of the state byte of the power supply. When the QUES bit is 0, the RIDFi outputs low level. When the QUES bit is 1, the RIDFi outputs high level.
- **OPER:** The EXT RIDFi terminal output level changes with the OPER bit of the state byte of the power supply.
- **ESB:** The EXT RIDFi terminal output level changes with the ESB bit of the state byte of the power supply.
- **RQS:** The EXT RIDFi terminal output level changes with the RQS bit of the state byte of the power supply.
- **OFF:** The EXT RIDFi terminal output level keeps low.

When the User uses this terminal function, the operations below should be followed:

1. Press the **[Menu]** key to enter the Menu Configuration page.
2. Select “Config > Conf2” to enter to Configuration Menu interface.
3. Select the “Digital Function” parameters by the   key. Press the right soft key corresponding to this parameter to set the external digital quantity control.
4. Press the **[RIDFi]** soft key to select the RIDFi function. At this time, pins 3/4 are capable of indicating power supply fault.

Digital IO output

DIGio1 (Pin 3) and DIGio2 (Pin 4) can be used as the common digital IO output terminals, which read and control the output terminal state through communication command. Under remote mode, the SCPI command (DIGital: DATA? and DIGital: DATA) can be sent to read and configure the output terminal state. High level is 5V and low level is 0V. When the User uses this terminal function, the operations below should be followed:

1. Press the **[Menu]** key to enter the Menu Configuration page.
2. Select “Config > Conf2” to enter to Configuration Menu interface.
3. Select the “Digital Function” parameters by the   key. Press the right soft key corresponding to this parameter to set the external digital quantity control.
4. Press the **[DIGio]** soft key to select the common digital IO terminal function.
5. Press the **[Esc]** key to return.

3.12 Series Operation

IT6411/IT6411S power supply supports series operation, series connection can be applied between same models to increase output power and output voltage, but it can't be applied between different models. IT6411/IT6411S power supply

supports up to two power supplies in series.

For example, the output specification of IT6411 is $\pm 15\text{V}(\pm 9\text{V}) / \pm 3\text{A}(\pm 5\text{A}) / 45\text{W}$, then the total output after series is $\pm 30\text{V}(\pm 18\text{V}) / \pm 3\text{A}(\pm 5\text{A}) / 90\text{W}$, the output power and output voltage are both double. The following figure shows an example of two IT6411 power supply in series operations.

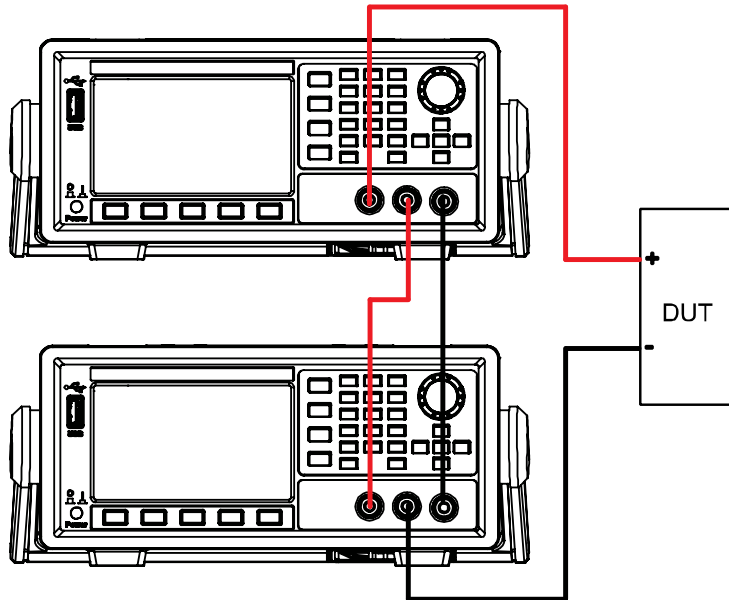

Chapter4 Power Supply Function

This chapter describes the features and use of the IT6400 series power supply in details.

4.1 Basic Concepts

IT6400 series has common power supply function, abundant basic electric energy measurement functions for precise measurement of voltage and current as well as DVM measurement.

Introduction of soft keys on the interface

On the Menu Configuration interface, select the **Source** to enter the Power Supply Function interface. As shown below:

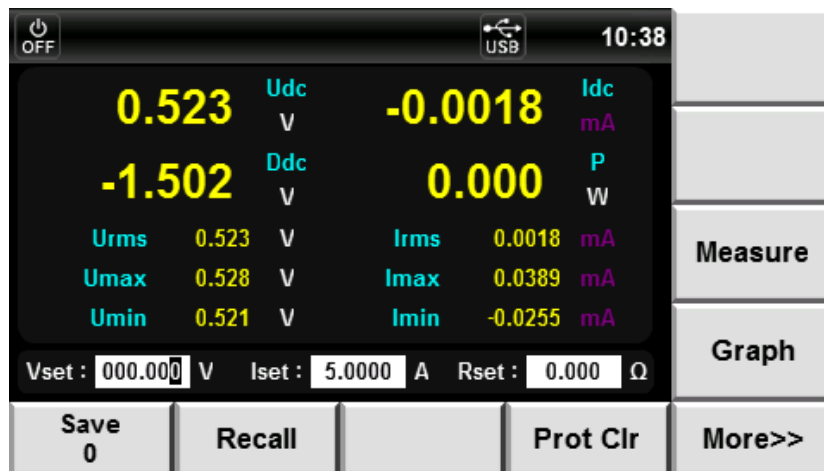

Description of Power Supply Function interface information:

Parameter name	Parameter description
Measure	Toggle key of display element: when this key is pressed, select the measurement parameters to be displayed in the interface.
Graph	Toggle key of Waveform Display interface: when this key is pressed, the present interface is ended and switched to the Graph interface.
More>>	More configurations (to be set).
Save	Save key: used for saving present configurations.
Recall	Recall key: used for recalling previous configurations.
Prot Clr	Clear protection status.

Description of power supply interface

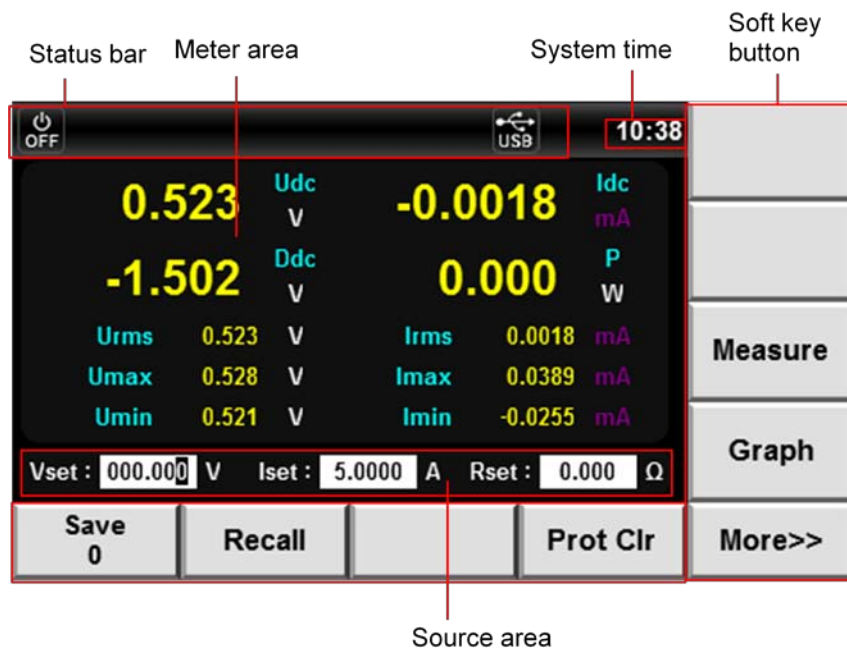

- **Channel meter area**

This area mainly displays measurement parameters of power supply, as follows:

Parameters	Parameter descriptions
Udc	Voltage average value [V]
Idc	Current average value [mA]
Ddc	DVM Measured Voltage average value [V]
Umax	The maximum voltage value [V]
Umin	The minimum voltage value [V]
Urms	Voltage effective value [V]

- **Channel source area**

This area mainly displays setting values of power supply, as follows:

Parameters	Parameter descriptions
Vset	Set up voltage output
Iset	Set up current output
Rset	Set up resistance output

Source output function

- **Voltage and current output**

High and low voltage output. Configure the voltage output range in the Voltage Range of Config Menu. Voltage and current output ranges are shown as follows.

Model	Voltage range	Voltage output range
IT6411	High	-15.1V ~ +15.1V Current output range: -3.05A ~ +3.05A
	Low	-9.05V ~ +9.05V

		Current output range: -5.05A ~ +5.05A
IT6411S	High	-15.1V ~ +15.1V
		Current output range: -0.1A ~ +0.1A
IT6431	High	-15.1V ~ +15.1V
		Current output range: -10.05A ~ +10.05A
IT6432	High	-30.1V ~ +30.1V
		Current output range: -5.05A ~ +5.05A
IT6433	High	-60.1V ~ +60.1V
		Current output range: -2.55A ~ +2.55A

- **Variable output impedance**

The output impedance of power supply can be configured from 0 to 1Ω.

Source measurement functions

- **Voltage and current range**

IT6411: Voltage rang 0 - 15.05V; current range 0 - 5.05A.

IT6411S: Voltage rang 0 - 15.05V; current range 0 – 0.1A.

IT6431: Voltage rang 0 – 15.05V; current range 0 – 10.05A.

IT6432: Voltage rang 0 - 30.1V; current range 0 - 5.05A.

IT6433: Voltage rang 0 - 60.1V; current range 0 – 2.55A.

- **The current measurement is divided into High range and Auto range.**

Take IT6411s as example, when Auto is configured, switch to Low mode when current is lower than 100uA. The measurement precision is 0.05%+50nA and resolution ratio 1nA.

- **Measured parameters**

Parameters	Parameter descriptions
Udc	Voltage average value [V]
Umax	The maximum voltage value [V]
Uhigh	The high voltage value [V]
Idc	Current average value [mA]
Imax	The maximum current value [mA]
Ihigh	The high current value [mA]
Ddc	DVM Measured Voltage average value [V]
P	Active power [W]
Urms	Voltage effective value [V]
Umin	The minimum voltage value [V]
Ulow	The low voltage value [V]
Irms	Current effective value [mA]
Imin	The minimum current value [mA]
Ilow	The low current value [mA]
Drms	DVM Measured Voltage effective value [V]

DVM Function

IT6400 series power supply is built in with a digital voltmeter (DVM), which can be used for measuring external voltage.

4.2 Setting of Measurement Function and Interface Display

The 4.3" colorful high-resolution TFT LCD of the IT6400 series power supply, 10 measurement parameters can be displayed in total, 4 of which are displayed in an amplified manner. The User can customize the parameter types and display sequences.

Operation steps

1. In the "Source" interface, press the **[Measure]** soft key to select measurement functions and configure interface display information.

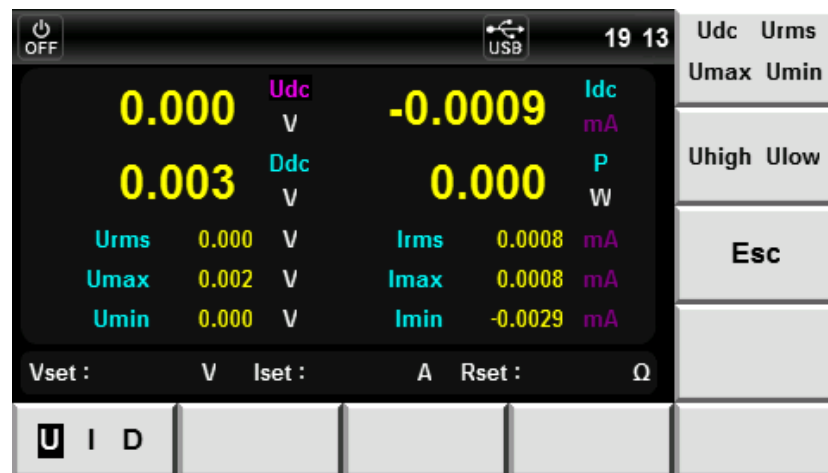

2. Press the **[U I D]** soft key to select the measurement function. For example, when the **[U I D]** key is pressed once, the displayed measurement function will be switched once in the U/I/D sequence. Different measurement parameters are displayed when different functions are selected.
 - **I (Current):** Irms, Idc, Imax, Imin, Ihigh, Ilow
 - **U (Voltage):** Urms, Udc, Umax, Umin, Uhigh, Ulow
 - **D (DVM):** Ddc, Drms, P
3. Press the "▲ ▼" key and move the cursor to select the parameter displayed in the interface (prunosis font background). Press the right soft key corresponding to this parameter to adjust the parameter displayed at present. Urms, rms, P and Ihigh are set in sequence.
4. Press the **[Esc]** soft key to exit Configuration interface.



Note

When the soft key corresponding to the parameter is pressed once, the parameter will be selected in sequence.

4.3 Setting of Output Parameters



Voltage setting

The voltage setting ranges from 0V to maximum output voltage. The voltage can be set in the **[Source]** interface. The output voltage can be set on the front panel according to the two methods below.

- Numeric keys (0-9) input:

By the  key, move the cursor to the Vset setting place and input the voltage value to be set. Press the **[OK]** key.

- Step-by-step input:

By the  key, move the cursor to the Vset setting place. Press the Right/Left () key in the Arrow keys to select the high and low position to be slightly adjusted (black font background). Rotate the Knob



to adjust the voltage set value.



Current setting

The current setting ranges from 0A to maximum output current. The current can be set in the **[Source]** interface. The output current can be set on the front panel according to the two methods below.

- Numeric keys (0-9) input:

By the  key, move the cursor to the Iset setting place and input the current value to be set. Press the **[OK]** key.

- Step-by-step input:

By the  key, move the cursor to the Iset setting place. Press the Right/Left () key in the Arrow keys to select the high and low position to be slightly adjusted (black font background). Rotate the Knob



to adjust the current set value.



Resistance setting

The resistance setting ranges from 0Ω to maximum output resistance. The resistance can be set in the **[Source]** interface. The output resistance can be set on the front panel according to the two methods below.

- Numeric keys (0-9) input:

By the  key, move the cursor to the Rset setting place and input the resistance value to be set. Press the **[OK]** key.

- Step-by-step input:

By the  move the cursor to the Rset setting place. Press the Right/Left () key in the Arrow key to select the high and low position

to be slightly adjusted (black font background). Rotate the Knob  to adjust the resistance set value.

4.4 Setting of Filter

Filter

The filter is inserted in the voltage and current measurement circuit and has direct influence on measurement of the voltage and current. When the filter is switched on, noise and high-frequency components from the inverter or

distortion waveform can be filtered. Cutoff frequency is 40HZ.

Operation steps

1. Select "Menu > Math > Filter" to enter Filter Configuration interface.
2. Press the ▲ ▼ key to select the parameter to be configured (prunosus font background), and then press the right soft key corresponding to this parameter to set the required value, as shown in the figure below.

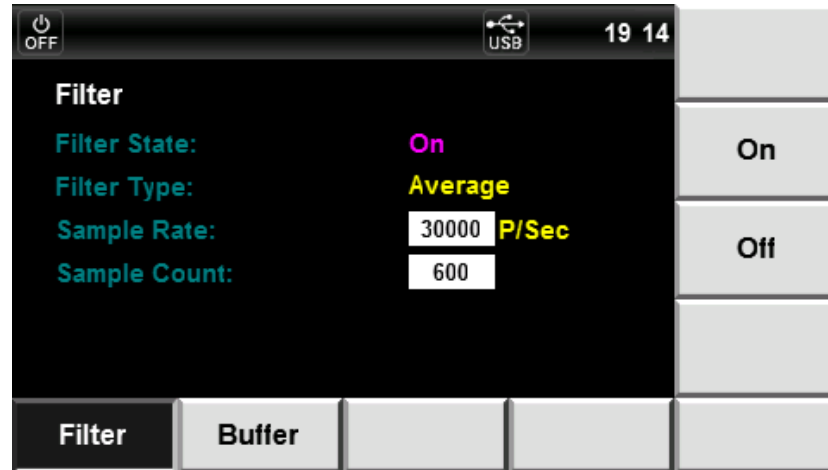

3. Select the parameters Sample Rate and Sample Count and directly change the values through Numeric keys or Knob.

Character	Function description
Filter State	Configure the filter state. When On is selected, the filter is turned on. When Off is selected, the filter is turned off.
Filter Type	Configure the filter algorithm type: Average filtering (Average), Hanning filtering (Hanning) and Rectangle filtering (Rectangle).
Sample Rate	Set the sample rate for data buffer.
Sample Count	Set the sample count for data buffer.

4. Press the [OK] key to save the setting information.

Chapter5 Waveform Display Function

This chapter describes the characteristics and use of the waveform display function of IT6400 series power supply in details.

5.1 Basic Concepts

IT6400 series power supply provides the waveform display function based on sample data. The voltage or current waveform of the input unit can be displayed or hidden on the interface, which is available for selection based on actual condition.

Introduction of soft keys on the interface

Select **Graph** in the Menu Configuration interface, the initial Waveform Display interface appears as follows.

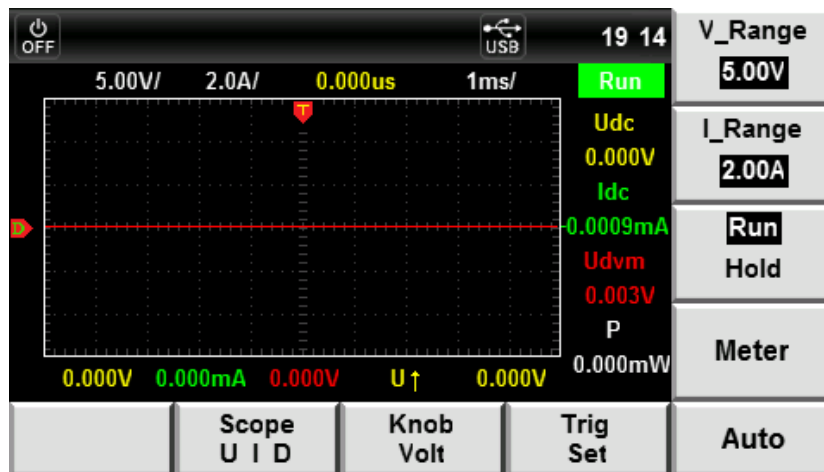

Description of Waveform Display interface information:

Parameter name	Parameter description
V Range	Voltage range setting: press the soft key corresponding to this parameter to set the voltage range.
I Range	Current range setting: press the soft key corresponding to this parameter to set the current range.
Run Hold	Run/stop: press the soft key corresponding to this parameter to run or stop the waveform status.
Meter	Toggle key of power supply measurement interface: when this key is pressed, the present interface is ended and switched to the Source interface.
Auto	Automatic adjustment key: when the soft key corresponding to this parameter is pressed, the power supply will automatically calibrate the input signal to display the best effect of the input signal.
Scope(U/I/D)	Select the waveform to be displayed on the display screen: voltage/current/DVM.

Parameter name	Parameter description
Knob Volt	Knob selection: the following variables can be adjusted by rotating the knob: vertical voltage position/vertical current position/trigger level/trigger delay/horizontal calibration/grounding level of DVM channel.
Trig Set	Trigger setting: the voltage, current and DVM triggering sources can be configured.

Introduction of Waveform Display interface

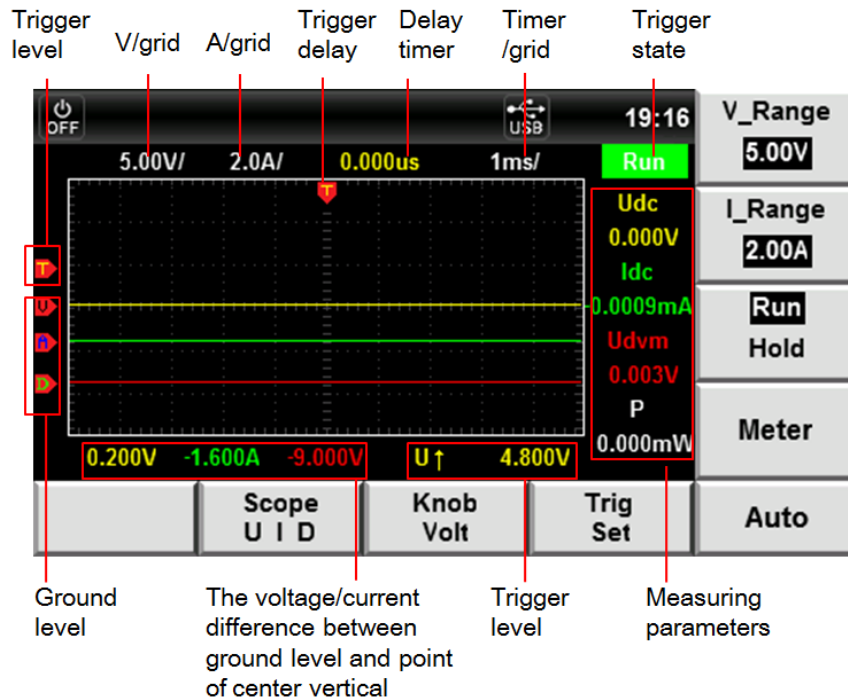

The trigger status is described as follows:

Trigger status	Instruction
Stop	When the trigger status is Run, press the “Run/Hold” soft key to change it to Stop.
Run	When the trigger status is Stop, press the “Run/Hold” soft key to change it to Run.

Trigger waveform

When the specified trigger conditions are satisfied, the trigger waveform will be displayed, and the triggering time point is called trigger point. The trigger point is generally displayed in the left of the display screen. Following the trigger point, the waveform is displayed on the display screen from left to right over time. Before using the trigger function, the user needs to configure the following parameters:

- **Trigger mode**

The trigger mode refers to conditions for updating the contents displayed on the screen. Including the Auto mode and Normal mode Auto mode: the displayed waveform is updated in case of triggering in the pause time and

automatically updated in case of no triggering in the pause time. Normal mode: the displayed content is updated in case of triggering and not updated in case of no triggering.

- **Trigger source**

The trigger source is used for generating triggering conditions. The user can select the trigger source from the voltage signal, current signal and the DVM signal of the input unit.

- **Trigger slope**

The slope refers to signal changes from low level to high level (rising edge) or from high level to low level (descending edge). When used as a triggering condition, the slope is called trigger slope.

- **Trigger level**

Trigger level occurs when trigger source signal reaches specified trigger level with specified trigger slope. When the **[Knob]** soft key is pressed and “T/Lev” is selected, the trigger level can be adjusted by rotating the knob. In this case, the trigger level can be changed by rotating the knob, and changes in the trigger level can be observed on the screen.

5.2 Setting of Knob Functions

The User can set the parameters to be adjusted by the Knob. When the Knob is rotated, corresponding parameter value on the interface will be changed. The following six types of parameters can be adjusted by Knob:

- Volt: grounding level of voltage channel;
- Ampe: grounding level of current channel;
- DVM: grounding level of DVM channel;
- T/Lev: trigger level;
- T/Del: trigger delay;
- T/Div: horizontal calibration (scanning speed).

Taking DVM Knob function as example, detailed operation steps are as below.

Operation steps

1. Select “Graph” in the Menu Configuration interface to enter the Waveform Display interface. The Knob is defaulted as adjusting grounding level of voltage channel. When the interface displays “Knob Volt”, it indicates that the Knob can adjust the grounding level of voltage channel, as follows:

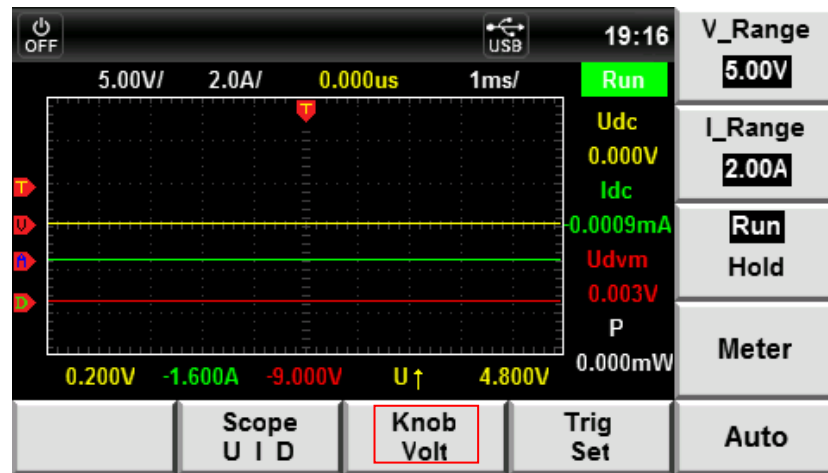

- On the Waveform Display interface, press the **[Knob Volt]** soft key to enter the Knob Setting interface, as shown below:

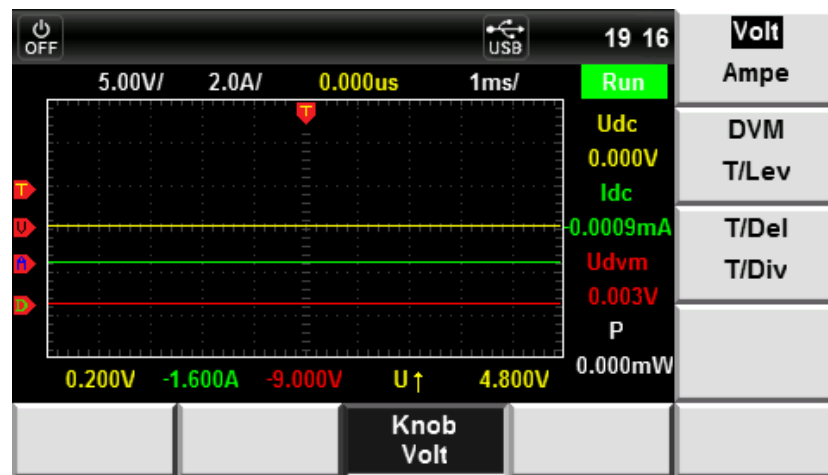

- Press the right **[DVM T/Lev]** soft key. The User can select the Knob function based on actual needs.

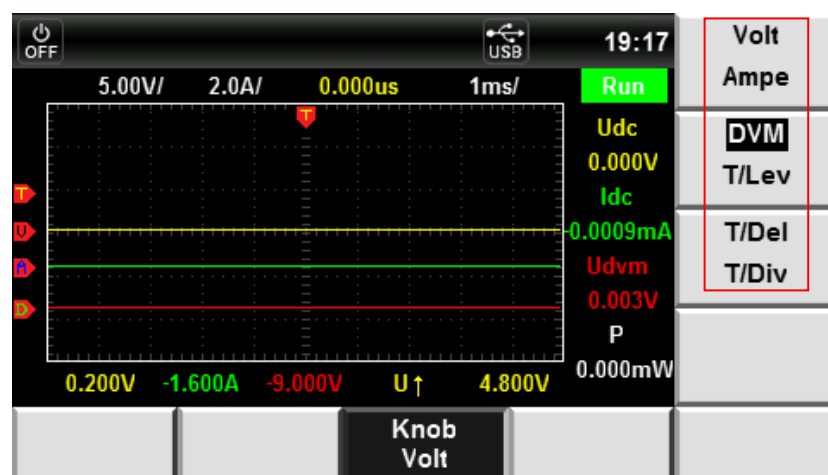

- In the above interface, press the **[Knob Volt]** soft key. In this case, "Knob DVM" is displayed, indicating that the Knob can adjust the grounding level of DVM channel.

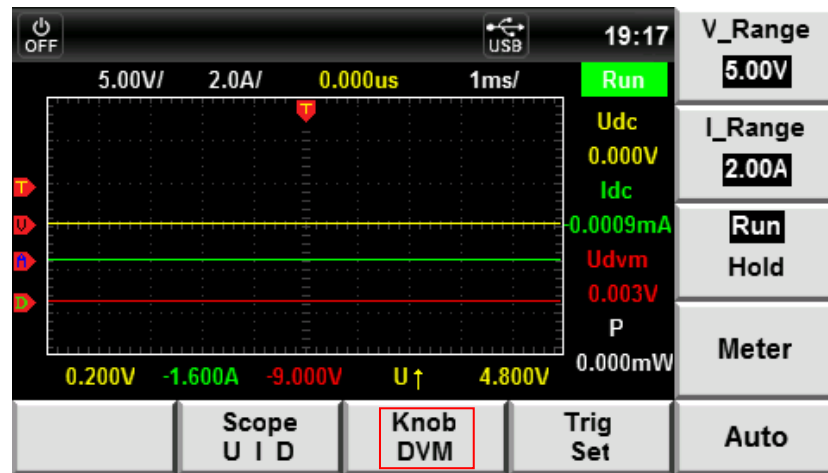

5.3 Horizontal Control and Vertical Control

Adjust horizontal (time/grid) calibration

When the **[Knob]** soft key is pressed and “T/Div” is selected, horizontal calibration (scanning speed) can be adjusted by rotating the knob. In this case, time/grid information changes can be observed on the screen by rotating the knob and changing the horizontal (time/grid) setting. When acquisition is run, the sampling rate can be changed by adjusting the horizontal calibration knob.

Adjust trigger delay (position)

When the **[Knob]** soft key is pressed and “T/Del” is selected, the trigger delay can be adjusted by rotating the knob. In this case, when the knob is rotated, the trigger point will move horizontally and the delay time will be displayed on the screen. When the delay time is changed, the trigger point (🔴) will move horizontally, and the distance between the trigger point and the horizontal center will be indicated. The trigger point is displayed along the top of the display grid.

Adjust vertical calibration

1. On the Waveform Display interface, press the **[V_Range]** or **[I_Range]** soft key to display the following interfaces:

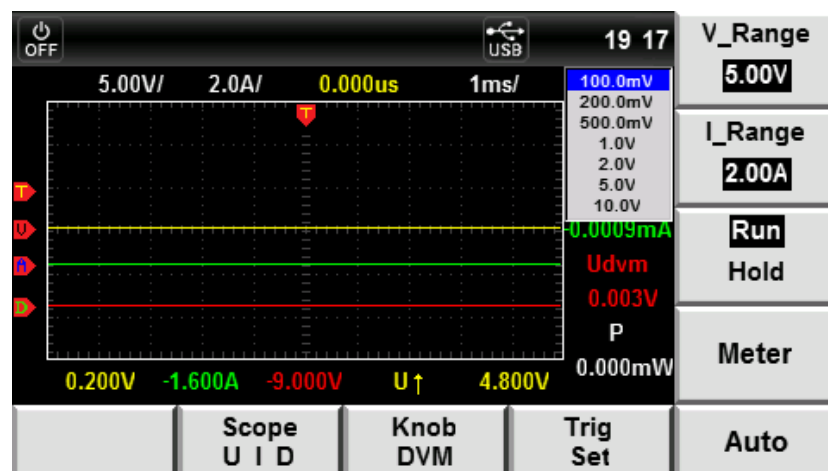

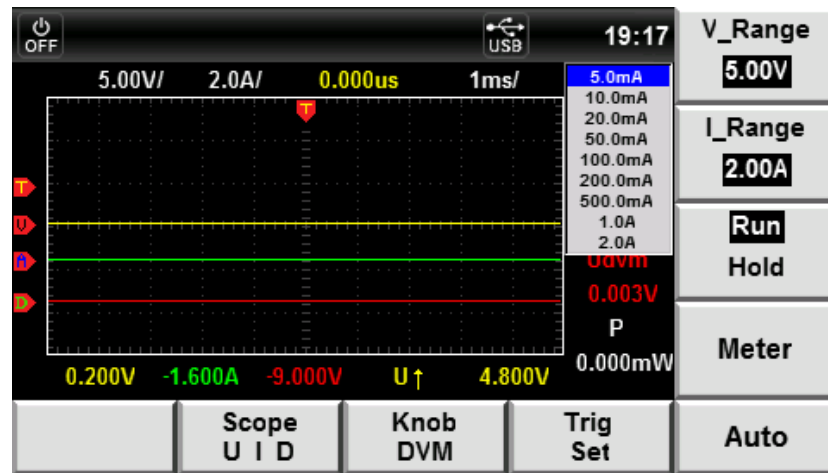

2. By the Knob or the ▲ ▼ key, select the vertical calibration (V/grid) of voltage or current.
3. Press the [OK] key to confirm the setting.

Adjust channel vertical position

When pressing the [Knob] soft key to select the “Volt” or “Ampe” or “DVM”, rotate the Knob to upward or downward move the waveform of voltage/current/DVM, and display the difference between the grounding level and vertical center of each channel value under the screen.

5.4 Setting of Trigger Configuration

When you need to enable the trigger function, you should select the trigger source, trigger mode, trigger slope and other trigger-related configuration. Detailed steps are as follows:

Operation steps

1. On the Waveform Display interface, press the [Trig Set] soft key to enter the Trigger Setting interface, as shown below:

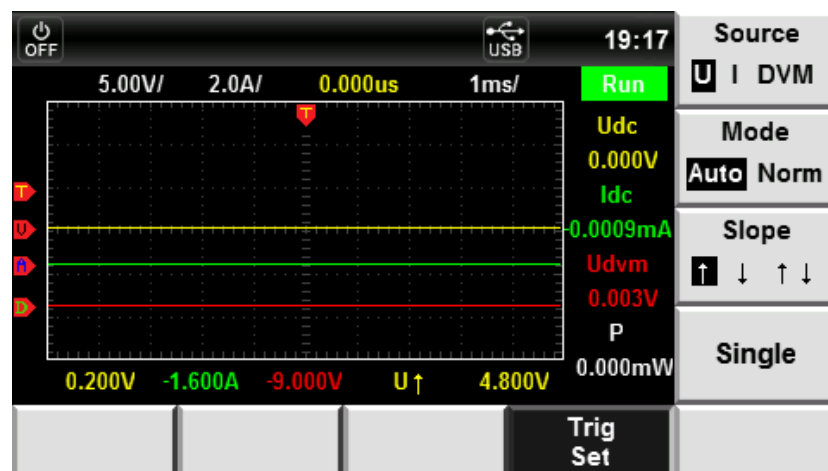

2. Press the right soft key corresponding to the parameter to select the required trigger configuration.
 - Source: Select the trigger source, voltage signal, current signal or

DVM signal.

- Mode: Select the trigger mode: Auto or Norm.
- Slope: Select trigger slope: rising edge (↑), descending edge (↓) or either edge (↑↓).
- Single: Single measurement key: when single measurement is performed under stop conditions, the stop status will be enabled again after one measurement according to the current data updating rate. When single measurement is performed under running conditions, one measurement will be performed immediately by the instrument and then the stop status will be enabled.

Chapter6 Battery Simulation Function

This chapter describes the features and use of the battery simulation functions of IT6400 series power supply in details.

6.1 Basic Concepts

With the unique current bipolar design and 0-1 Ω variable output impedance, IT6400 series is applicable to types of portable battery charge-discharge tests. Simulating the battery charge-discharge features and assisting with other tests are also reliable. One equipment, diversified applications.

Introduction of soft keys on the interface

On the Menu Configuration interface, select “**Battery**” to enter the Battery Simulation Function interface. As shown below:

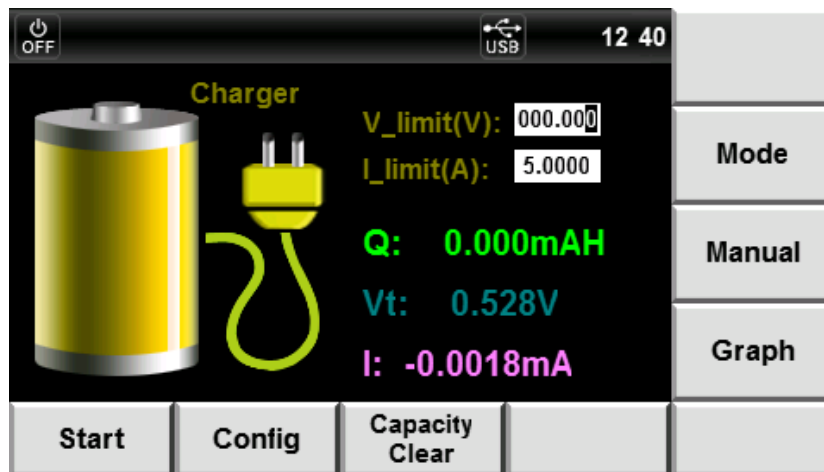

Description of the Battery Simulation Function interface information:

Parameter name	Parameter description
Mode	Select mode: Charger (battery charge mode), Discharger (battery discharge mode), Simulator (battery characteristic simulation)
Manual	Configure various parameters for battery characteristic simulation on the panel.
Graph	Toggle key of Waveform Display interface: when this key is pressed, the present interface is ended and switched to the Graph interface.
Start	Start test
Config	Configure the stop conditions for battery charging/discharging/simulation test
Capacity Clear	Clear capacity

Introduction of Battery Charger interface

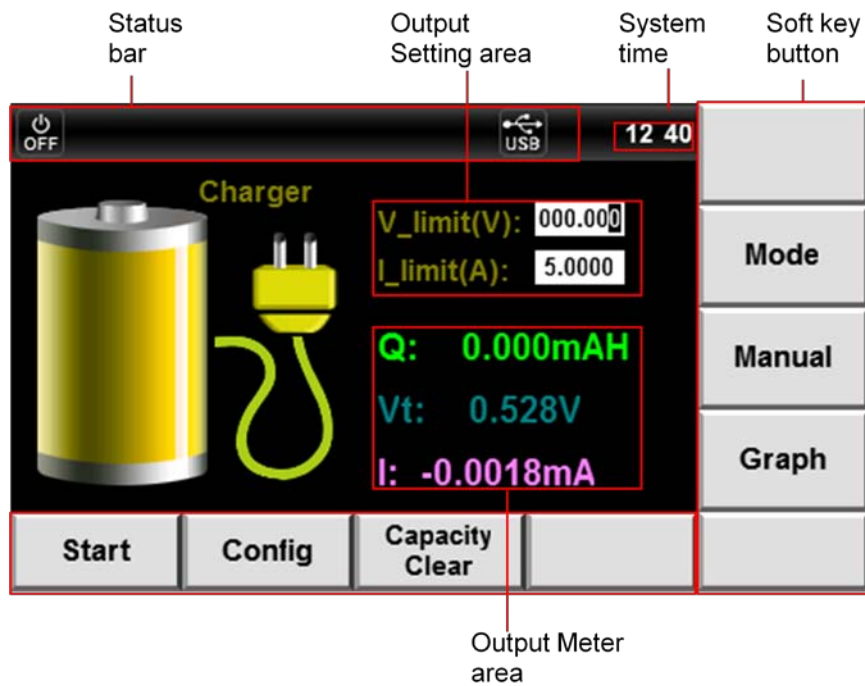

Output setting/meter area

This area mainly displays setting/measurement parameters, as follows:

Parameter	Parameter description
V_limit(V)	Charged voltage
I_limit(A)	Charged current
Q(mAH)	Battery capacity
Vt(V)	The real terminal voltage of the battery
I(mA)	The charging/discharging current

Introduction of Battery Simulation interface

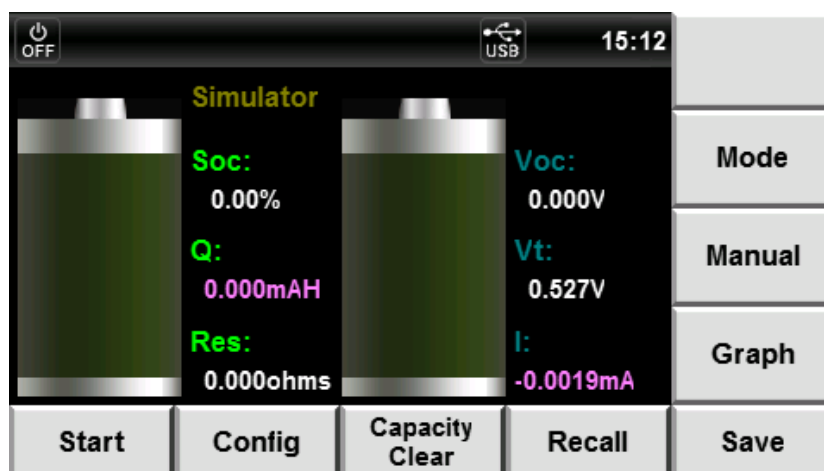

Parameter descriptions is shown as follows.

Parameter	Parameter description
Soc(%)	The capacity in percentage

Parameter	Parameter description
Q(mAH)	The battery capacity
Res(ohms)	The battery resistance
Voc	The open-circuit voltage of the battery
Vt(V)	The real terminal voltage of the battery
I(mA)	The charging/discharging current

During charging and discharging of battery, as the battery capacity increases, the corresponding open circuit voltage rises and the internal resistance drops; on the contrary, as the capacity decreases, the open circuit voltage drops and the internal resistance rises. The relationship among battery capacity, open circuit voltage and battery internal resistance is as shown below:

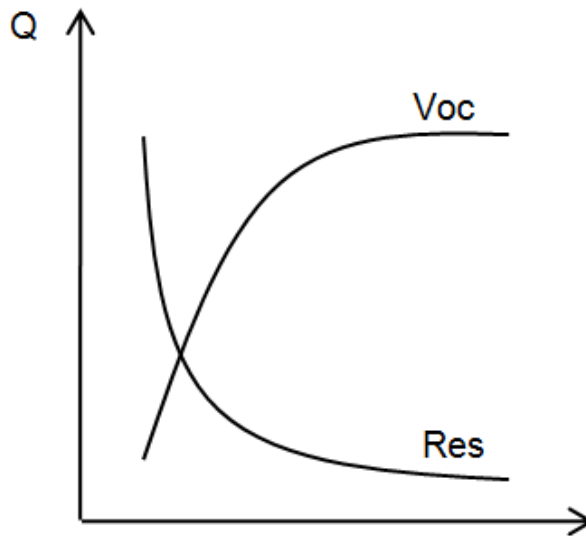

Stop conditions for battery test

On the Battery Simulation Function interface, press the **[Config]** soft key to enter the Stop Condition Configuration interface of battery test.



Parameter	Parameter description
Voltage Shut(V)	Configure shut-off voltage
Current Shut(A)	Configure shut-off current
Capacity Shut(mAH)	Configure shut-off capacity

Parameter	Parameter description
Time Shut(s)	Configure time for configuring battery charging/discharging/simulation

6.2 Battery Charging Function

IT6400 series power supply are provided with battery charging function. After selecting the battery charging mode (Charge), the “Charging voltage” (V_limit) and charging current (I_limit) under the charging mode can be set. During the charging, the voltage, current and charged capacity of the battery can be observed.

Operation steps

1. Press the **[Menu]** key to enter the Menu Configuration page.
2. Select **“Battery”** to enter the Battery Simulation Function interface.
3. Press the right **[Mode]** soft key to select test mode.

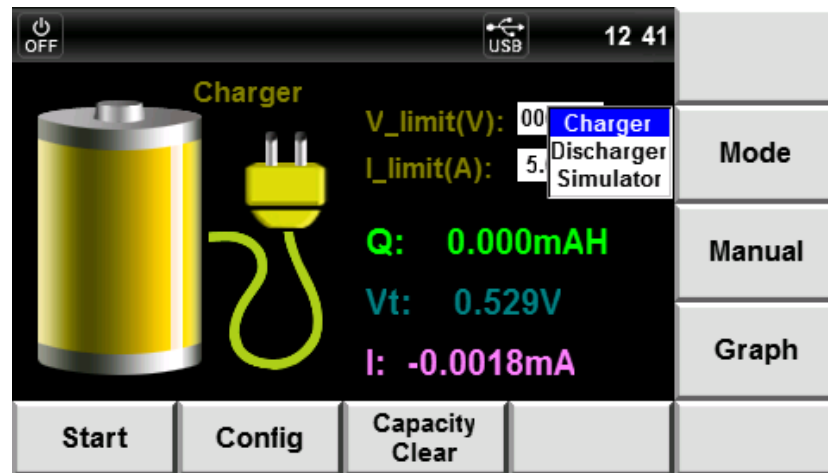

4. Use the **▲ ▼** key or the Knob to select the “Charge” (blue font background). Press the **[OK]** key for confirmation.
5. By the **▲ ▼** key, move the cursor to the V_limit setting place and set the charging voltage value. Press the **[OK]** key for confirmation.
6. By the **▲ ▼** key, move the cursor to the I_limit setting place and set the maximum charging current value. Press the **[OK]** key for confirmation.
7. Press the **[Config]** soft key to enter the Stop Condition Configuration interface for configuring the stop conditions of battery charging test. Press the **[Esc]** soft key to return to the Test interface.
8. Press the **[Start]** soft key to start battery charging test (power output On).
9. When the battery meets the set charging stop conditions, the battery output status will automatically be Off. Or, press the **[Stop]** soft key to stop test.

6.3 Battery Discharging Function

IT6400 series power supply is provided with battery discharging function. After selecting the battery discharging mode (Discharge), the “Discharging voltage”

(V_limit) and discharging current (I_limit) under the discharging mode can be set. During the discharging, the voltage, current and discharged capacity of the battery can be observed.

Operation steps

1. Press the **[Menu]** key to enter the Menu Configuration page.
2. Select “**Battery**” to enter the Battery Simulation Function interface.
3. Press the right **[Mode]** soft key to select test mode.

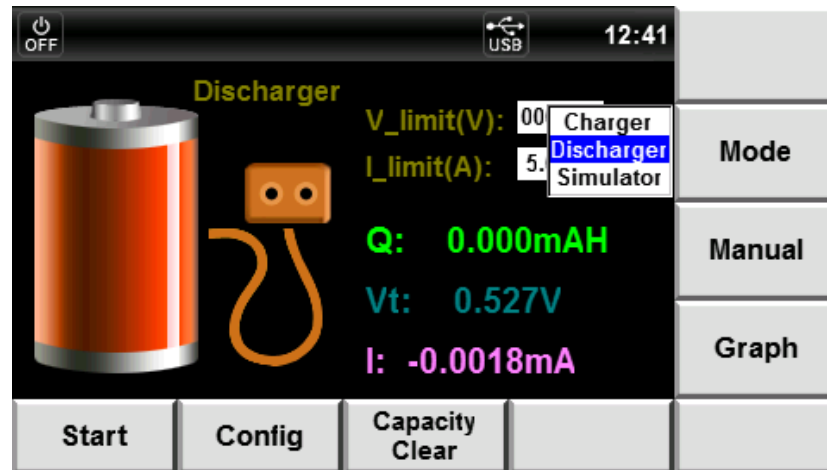

4. Use the ▲ ▼ key or the Knob to select the “Discharge” (blue font background). Press the **[OK]** key for confirmation.
5. By the ▲ ▼ key, move the cursor to the V_limit setting place and set the discharging voltage value. Press the **[OK]** key for confirmation.
6. By the ▲ ▼ key, move the cursor to the I_limit setting place and set the maximum discharging current value. Press the **[OK]** key for confirmation.
7. Press the **[Config]** soft key to enter the Stop Condition Configuration interface for configuring the stop conditions of battery discharging test. Press the **[Esc]** soft key to return to the Test interface.
8. Press the **[Start]** soft key to start battery discharging test (power output On).
9. When the battery meets the set discharging stop conditions, the battery output status will automatically be Off. Or, press the **[Stop]** soft key to stop test.

6.4 Battery Characteristic Simulation

IT6400 series power supply supports the battery characteristic simulation function. The User should firstly edit the battery characteristic data, including voltage, resistance and capacity. The battery characteristic data can be edited according to the two methods: panel editing and external data import, i.e., select the characteristic data after editing or import the external data to the IT6400 series power supply.

6.4.1 Introduction of Manual interface

Select “Manual” on the Battery Simulation Function interface to enter the Panel

Edit interface. The User can edit 20 groups of battery characteristics data at maximum. A maximum of 20 steps (Point 0 to Point 19) can be configured in each group. The User should edit the capacity, voltage and resistance of each step.

Introduction of Manual interface

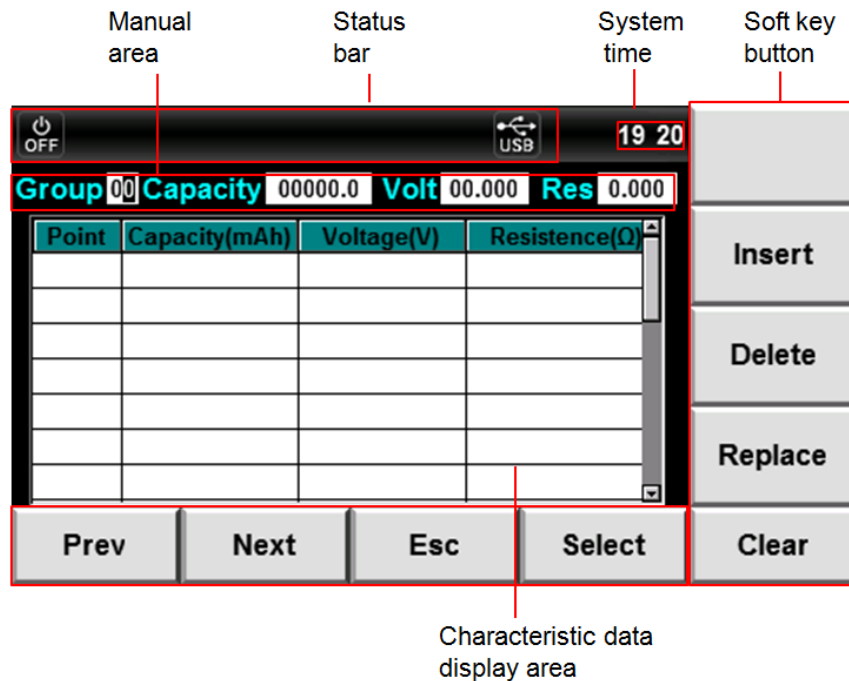

- Manual edit area

This area mainly displays editable parameters, as follows:

Parameter	Parameter description
Group	Characteristic data group (0 - 19)
Capacity	Configure battery capacity
Volt	Configure voltage for single step
Res	Configure resistance for single step

- Display area of characteristic data

This area mainly displays the edited battery characteristic data group. Use

▲ ▼ to roll and view this list.

Introduction of soft keys on the Manual interface

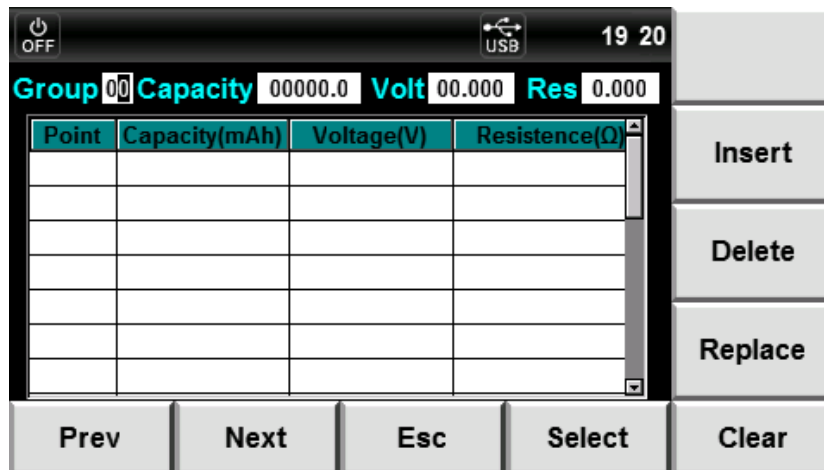

Description of Manual Edit interface information:

Parameter name	Parameter description
Insert	Insert: insert 1 step following the present step by pressing the soft key corresponding to this parameter
Delete	Delete: delete the present step by pressing the soft key corresponding to this parameter
Replace	Replace: replace the present step by pressing the soft key corresponding to this parameter
Previ	Previous: select the previous step of the present step by pressing the soft key corresponding to this parameter
Next	Next: select the next step of the present step by pressing the soft key corresponding to this parameter
Esc	Return to the Battery Simulation Function interface.
Select	Select the battery characteristic data group.
Clear	Clear the battery characteristic data under editing.

6.4.2 Battery Characteristic Simulation Operation

Edit the battery characteristic data

Operations for panel editing are as follows:

1. Press the **[Menu]** key to enter the Menu Configuration page.
2. Select **"Battery"** to enter the Battery Simulation Function interface.
3. Select **"Manual"** to enter Manual Edit interface.
4. Configure Group number. By the ▲ ▼, move the cursor to the Group setting place and press the Numeric key or Knob to set the number value. In this example, the Group number is set as 03.
5. Configure step capacity (Capacity), step voltage (Voltage) and step resistance (Resistance). By the ▲ ▼, move the cursor to the Capacity, Volt and Res setting place and press the Numeric key or Knob for setting. In this example, each value is set as follows.

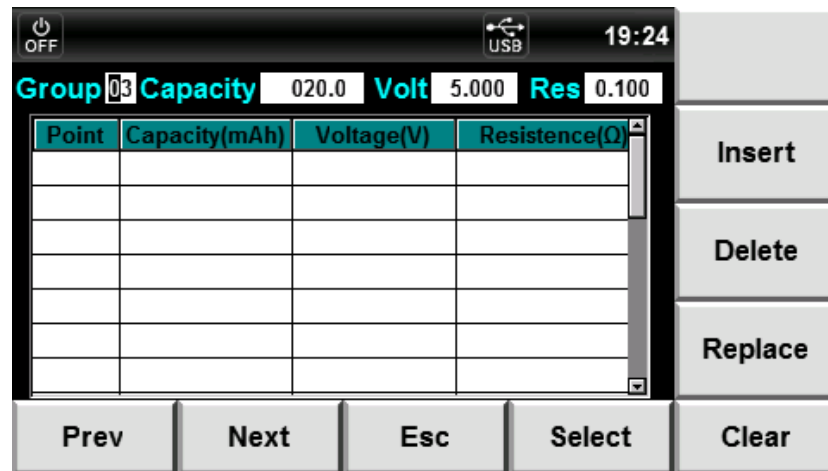

6. Press the **[Insert]** soft key to insert the present set value to the list as the 0th step of the Group 03.



7. Repeat Steps 6 - 7 to set the other 2 steps in Group 03.



8. After editing, press the **[Esc]** key to return.

Import the external battery characteristic data

IT6400 series can import the external battery characteristic data and recall it at simulation operation. Operating procedures are as below:

1. Create a new Excel document on local PC and name it BATTERY.csv.
2. Open the Excel document and save it as in “other formats” in “(*.csv)”.
3. Open the BATTERY.csv document and edit the battery characteristic simulation function in the .csv document, including voltage, resistance and capacity.
4. Insert the USB (containing BATTERY.csv document) to the USB interface on the front panel of power supply.

	A	B	C	D
1	Capacity (mAh)	Voltage (V)	Resistance (Ω)	
2	1800	3.7	0.03	
3	1500	3.5	0.05	
4	1000	3.4	0.1	
5	500	3.32	0.15	
6	100	3.3	0.2	
7				

5. On the Battery Simulation Function interface, press the **[Mode]** soft key to select test mode Simulator, and press the **[OK]** key for confirmation.
6. Press the **[Save]** soft key and the display screen prompts “Please Import Battery.csv File”, “Importing, Please Wait...”, “Import Finished!” and “Please Select Group 00” in order. Select the group in which the characteristic data is to be saved.

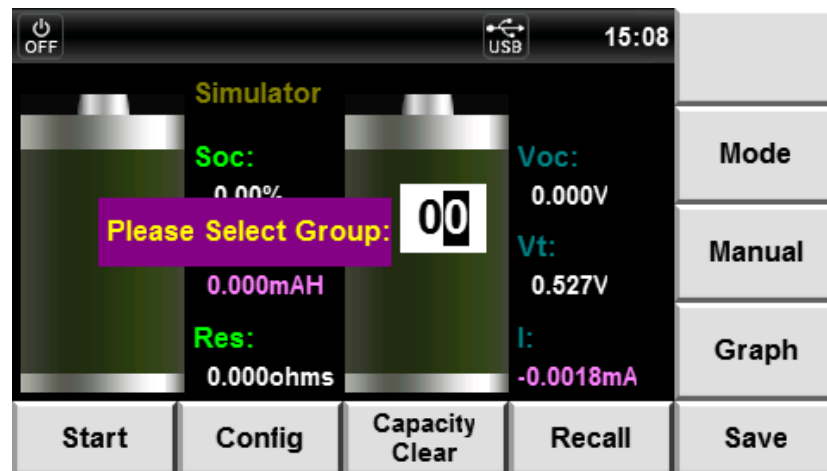

7. Press the Numeric key or Knob to set the group number. For example, save the data in Group 5 and press the **[OK]** key for confirmation.
8. The screen prompts “Saved!”, and the external data are successively saved.

Recall the battery characteristic data group.

If several battery characteristic data groups are edited, the User may select the ones to be recalled. Operating procedures are as below:

1. On the Battery Simulation Function interface, press the **[Mode]** soft key to select test mode Simulator, and press the **[OK]** key for confirmation.



2. Press the **[Recall]** soft key to enter the Data Group Recall interface.

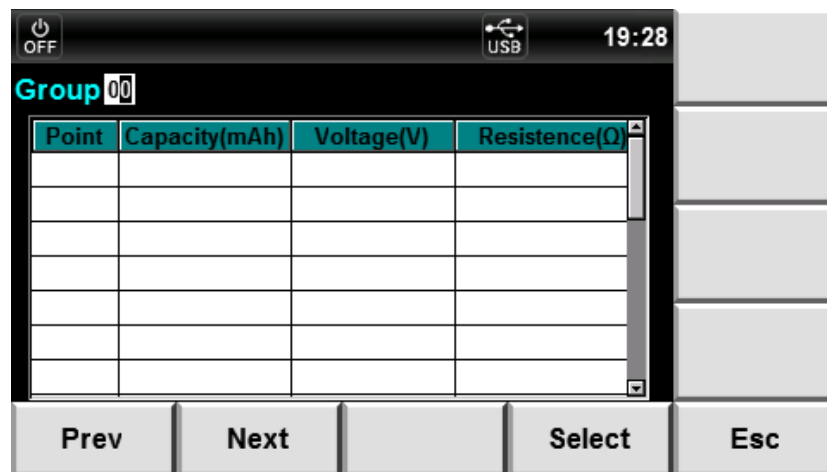

3. Configure Group number. By the ▲ ▼, move the cursor to the Group setting place and press the Numeric key or Knob to set the number value of the data group to be recalled. Press the **[OK]** key for confirmation. At this time, the characteristic data display area displays the characteristic data of each step in this group.



4. Press the **[Select]** soft key to recall data group.
5. Press the **[Esc]** soft key to return to the Battery Simulation Function interface.

Battery characteristic simulation operation

1. Press the **[Menu]** key to enter the Menu Configuration page.
2. Select **"Battery"** to enter the Battery Simulation Function interface.
3. Press the **[Mode]** soft key to select test mode.

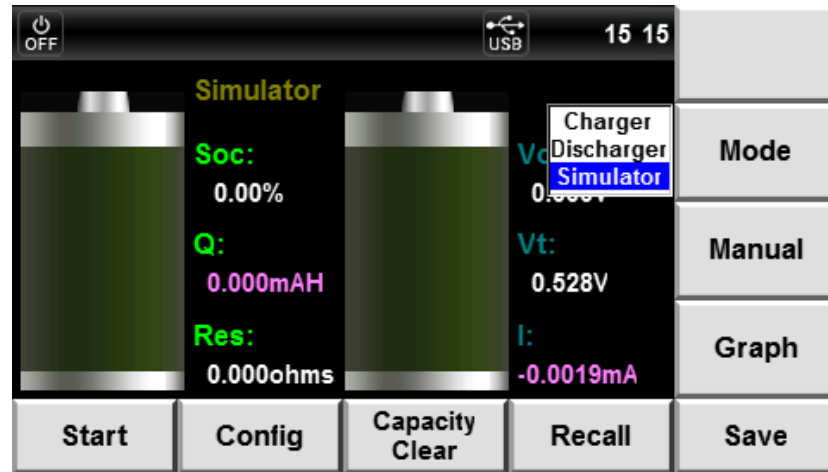

4. Use the ▲ ▼ key or the Knob to select the "Simulator" (blue font background). Press the **[OK]** key for confirmation.
5. Press the **[Save]** soft key. When the display screen prompts "Please Import Battery.csv File", import the external battery characteristic data.
 - **External import:** Insert the USB (containing BATTERY.csv document) to the USB interface on the front panel of power supply. The power supply automatically detects and imports the BATTERY.csv document.
 - **Internal recall:** Select the data group in which recall is required based on the above steps in "Edit the battery characteristic data" and "Recall the battery characteristic data group".
6. Press the **[Config]** soft key and then input the maximum test current of the battery characteristic simulation in the "Current Shut(A)" column.
7. Press the **[Start]** soft key to start battery simulation test.
8. The power supply will automatically switch off the output, once the battery according to the characteristic data completes the test or the setting conditions for stopping the test is reached. You can press **[Stop]** to pause the test during the battery simulation test. And press **[Capacity Clear]** to restart the test.

Chapter7 List Function

This chapter describes the features and use of the List function of the IT6400 series power supply in details.

7.1 Basic Concepts

The User can edit the test procedures composed of several steps through the List function. There are 20 Lists (List 0 to List 19) under the List function for selection, which can be controlled through the Select parameters on the interface. Values are as follows:

- Y: this List is selected and executable.
- N: this List is neither selected nor executable.

The User can flexibly select the List to form different sequence output. A maximum of 30 steps (Point 0 to Point 29) can be configured in each List. The User can edit the voltage, current, resistance and step time. Relationship between List and Sequence is shown below.

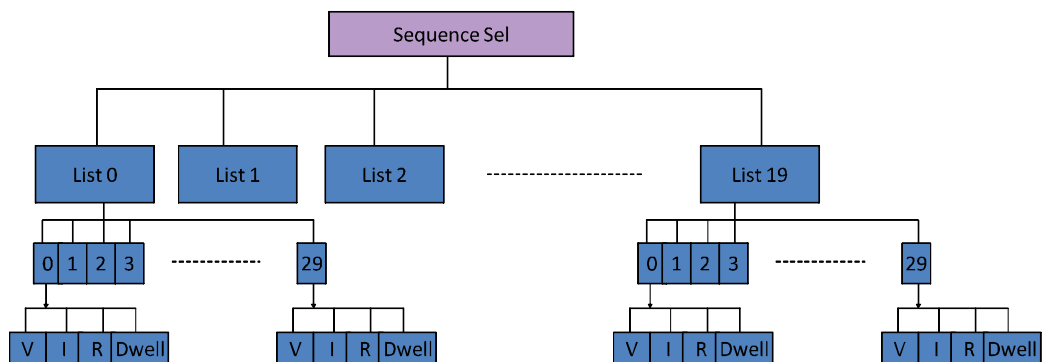

Introduction of soft keys on the interface



Description of List Function interface information:

Parameter name	Parameter description
Insert	Insert: insert 1 step following the present step by pressing the soft key corresponding to this parameter.
Delete	Delete: delete the present step by pressing the soft key corresponding to this parameter.
Replace	Replace: replace the present step by pressing the soft key corresponding to this parameter.
Prev	Previous: select the previous step of the present step by pressing the soft key corresponding to this parameter
Next	Next: select the next step of the present step by pressing the soft key corresponding to this parameter.
Sequence Sel	Select Sequence.
External Import	Import external List documents.
Clear	Clear the List under editing.

Introduction of List interface

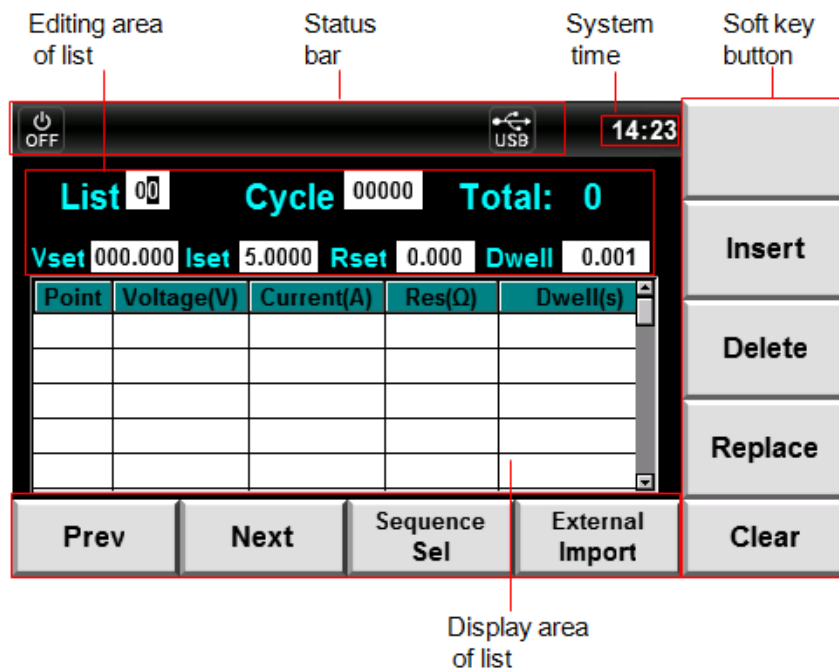

- List edit area

This area mainly displays editable parameters of List function, as follows:

Parameter	Parameter description	Parameter	Parameter description
List	List sequence (0-19)	Cycle	Cycle times
Total	Total number of steps (0-29)	Vset	Configure step voltage
Iset	Configure step current	Rset	Configure step resistance
Dwell	Configure step time	-	-

- List display area

This area mainly displays the edited List. Use ▲ ▼ to roll and view this list.

7.2 List Operation

Configure trigger mode

Before editing List on the panel, firstly set the trigger as Internal (manual trigger). For details, refer to 3.9 Triggering Function.

Edit List

1. Press the **[Menu]** key to enter the Menu Configuration page.
2. By the ▲ ▼ key, select **List**. Press the **[OK]** key for confirmation. The display screen displays “List Config, Please Wait...” and “Config Done”. Enter the List Function Display interface.



3. Configure List number. By the ▲ ▼, move the cursor to the List setting place and press the Numeric key or Knob to set the number value. In this example, the List number is set as 02.
4. Use the ▲ ▼ key to adjust the cursor position and set the values of Cycle, Vset, Iset, Rset and Dwell.



5. Press the **[Insert]** soft key to insert the present set value to the list as the

0th step of the List 02. The Total value increases accordingly with every insertion of step.



List 02 Cycle 0003 Total: 1
 Vset 2.100 Iset 0.5000 Rset 0.200 Dwell 5.000

Point	Voltage(V)	Current(A)	Res(Ω)	Dwell(s)
0	2.100	0.5000	0.2000	5.000

Prev Next Sequence Sel External Import Clear

6. Repeat Steps 5 - 6 to set the other three steps in List 02.



List 02 Cycle 0003 Total: 4
 Vset 2.200 Iset 0.6000 Rset 0.100 Dwell 5.000

Point	Voltage(V)	Current(A)	Res(Ω)	Dwell(s)
0	2.100	0.5000	0.2000	5.000
1	2.200	0.5000	0.2000	5.000
2	2.200	0.6000	0.2000	5.000
3	2.200	0.6000	0.1000	5.000

Prev Next Sequence Sel External Import Clear

7. The User can repeat the above steps to edit other Lists. In this example, edit the List 03 in power supply.



List 3 Cycle 3 Total: 4
 Vset 03.000 Iset 0.4000 Rset 0.334 Dwell 5.000

Point	Voltage(V)	Current(A)	Res(Ω)	Dwell(s)
0	2.600	0.3000	0.3340	5.000
1	2.700	0.3000	0.3340	5.000
2	2.700	0.4000	0.3340	5.000
3	3.000	0.4000	0.3340	5.000

Prev Next Sequence Sel External Import Clear List

External import of List

IT6400 series power supply is provided with external import of List documents. The User can import the local-edited List documents to the power supply. This

function simplifies the List document edit and facilitates user operation. Detailed operation steps are as below:

1. Create a new Excel document on local PC and name it List.
2. Open the Excel document and save it as in “other formats” in “(*.csv)”.
3. Open the List.csv document and edit the List. Set every step of the List and corresponding parameters.

	A	B	C	D	E
1	Voltage(V)	Current(A)	Resistance(Ω)	Dwell(s)	
2	5	1	0.1	5	
3	4	1	0.1	5	
4	2	1	0.1	5	
5	2	1	0.1	5	
6	1	1	0.1	5	
7					

4. Insert the USB (containing List.csv document) to the USB interface on the front panel of power supply.
5. Press the **[External Import]** soft key and the power supply will automatically identify the .csv document in the USB and import it.



6. By the ▲ ▼, move the cursor to the List setting place and press the Numeric key or Knob to set the List number value.
7. Press the [OK] key for confirmation and complete the List document import.

Select Sequence.

If several Lists are edited, the User may select the required ones. Operating procedures are as below:

1. Press the **[Sequence Sel]** soft key to enter the Sequence Selection interface. The User can select the active List on this interface.

Power	USB	Time	Col 1	Col 2	Col 3	Col 4	Col 5	Col 6	Col 7	Col 8
OFF	USB	15:54	List	Cycle	Sel	P	V	I	R	D
			0	0	N	0	2.100	0.500	0.200	5.000
			1	0	N	1	2.200	0.500	0.200	5.000
			2	3	N	2	2.200	0.600	0.200	5.000
			3	3	N	3	2.200	0.600	0.100	5.000
			4	0	N	4	0.000	0.000	0.000	0.000
			5	0	N	5	0.000	0.000	0.000	0.000
			6	0	N	6	0.000	0.000	0.000	0.000
			7	0	N	7	0.000	0.000	0.000	0.000
			Prev	Next	Esc	Off				

- Use the ▲ ▼ key to select the line of the List 02 (blue background). Press the soft key corresponding to the [Y] to select List 02 list.
- Use the ▲ ▼ key to select the line of the List 03 (blue background). Press the soft key corresponding to the [Y] to select List 03 list.

Power	USB	Time	Col 1	Col 2	Col 3	Col 4	Col 5	Col 6	Col 7	Col 8
OFF	USB	15:55	List	Cycle	Sel	P	V	I	R	D
			0	0	N	0	2.600	0.300	0.334	5.000
			1	0	N	1	2.700	0.300	0.334	5.000
			2	3	Y	2	2.700	0.400	0.334	5.000
			3	3	Y	3	3.000	0.400	0.334	5.000
			4	0	N	4	0.000	0.000	0.000	0.000
			5	0	N	5	0.000	0.000	0.000	0.000
			6	0	N	6	0.000	0.000	0.000	0.000
			7	0	N	7	0.000	0.000	0.000	0.000
			Prev	Next	Esc	Off				

Run List

After editing of List, the power supply will start running after receipt of one trigger signal till completion of the List operation or receipt of another trigger signal.

Operating procedures are as below:

- Edit List in successive based on the above steps and select the edited List.
- On the Sequence Selection and Configuration interface, press the [Off] soft key to configure the List status as On and switch on the List function.

List	Cycle	Sel	P	V	I	R	D
0	0	N	0	2.600	0.300	0.334	5.000
1	0	N	1	2.700	0.300	0.334	5.000
2	3	Y	2	2.700	0.400	0.334	5.000
3	3	Y	3	3.000	0.400	0.334	5.000
4	0	N	4	0.000	0.000	0.000	0.000
5	0	N	5	0.000	0.000	0.000	0.000
6	0	N	6	0.000	0.000	0.000	0.000
7	0	N	7	0.000	0.000	0.000	0.000

OFF USB 15:55

Y N

Prev Next Esc On

3. Press the **[On/Off]** key on front panel of the power supply to switch on the output.
4. Press the **[Trig]** key on the front panel to trigger the running of List document under editing. At this time, the status bar displays , indicating that the List is running.

Exit LIST

Refer to the steps below to exit the present List operation mode.

1. Press the **[Sequence Sel]** soft key on the List interface to enter the Sequence Configuration interface.
2. Press the **[On]** soft key to set the List status as Off. And the instrument will exit the List operation mode.

Chapter8 Routine Maintenance

This chapter describes general maintenance items and maintenance methods of the IT6400 series power.

8.1 Error Information References

This section describes all error information of the IT6400 series power as well as error causes and disposals. All prompt information is listed.

Prompt message list

Prompt information
SelfTest is working!
Saving Screen, Please Wait...
Saving Screen success
Please Import Battery.csv File
List Config, Please Wait...
Config Done
Please input Calibration Code
Please Contact us!
System Reset All?
Reset, Please Wait.
System Reset Done
System Log Recording...
Please Insert USB Device!

Error information list

Error information	Error information explanation
usb is not detected	[Error description] No USB peripheral is found. [Possible cause] No USB peripheral is inserted. [Disposal] Insert the U disc type USB peripheral and then copy the screen.
Code Error!	[Error description] Code error. [Possible cause] Code input error. [Disposal] Please input code again.

8.2 Daily maintenance

Introduce basic maintenance in daily use of equipment. Such as cleaning, self-maintenance allowed to be performed by the user, etc.

Equipment cleaning

Use dry cloth or slightly wet cloth to gently wipe the equipment. Do not arbitrarily wipe the inside of the instrument. Cut off the power supply before cleaning.

8.3 Contact of ITECH Engineers

This section describes operations to be carried out by the user in case of failure of the instrument.

Preparation before contact

When the instrument fails, you should make the following preparations before returning the instrument to ITECH for repair or contacting engineers.

1. Check all the items listed in the “Self-inspection of Equipment Faults” and confirm whether there are still some problems.
2. If there are still some problems, carefully read the contents of warranty services and warranty restrictions in the preface of the manual. Confirm that our instrument complies with warranty service conditions.
3. If you want to send the instrument to the manufacturer for repair, refer to instructions in “8.5 Returning Your Power for Service”.

Self-inspection of equipment faults

In case of failure of the instrument, self-inspect the following items. If the instrument failure can be eliminated via simple inspection, the maintenance cost and time can be saved. Please check the following items before contacting the engineer of ITECH.

- Check whether the power supply is powered up.
- Check whether the power supply is started normally.
- Check whether the instrument fuse is in good conditions.
- Check whether other connectors are in good conditions and whether cables, plugs and other parts are connected properly.
- Check whether the system configuration of the instrument is correct during use.
- Check whether self-inspection of the instrument is successful and whether the specifications and performance are within the indicator ranges.
- Check whether the instrument displays error information.
- Use other instruments instead of this instrument for confirmation.

Collect the SN number

ITECH will constantly improve the product performance, availability and reliability. The service personnel of ITECH will record changes of each instrument. All relevant information is marked uniquely according to the serial number of each instrument. The equipment returned for repair must adopt the SN number as the tracking ID.

When you contact the engineer, the effective SN number of the instrument will be the effective guarantee for effective service and complete information. You can obtain the SN number of the instrument by the following ways:

1. Press the **[Menu]** key to enter the menu setting page of the power supply.
2. Select “System” to enter system menu page.
3. Press the **[Sys Info]** to enter “System Infomation” interface to view the product model, product SN, software version number and other information.

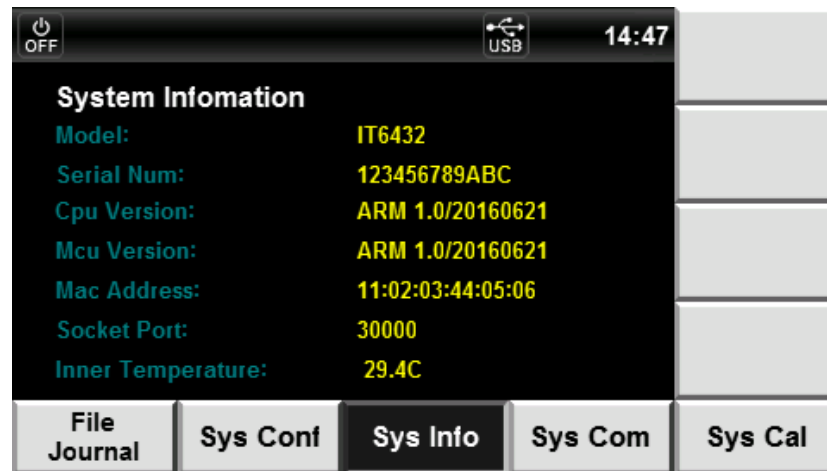

4. In this page, Serial is the instrument SN number. Please record the SN number.

Calibration Interval

ITECH suggests that the IT6400 series power calibration frequency is 1 time/year.

8.4 Returning Your Power for Service

When you want to return your power to ITECH company, please read the following information.

Package the power supply for Shipment

When instruments are required for factory maintenance, please refer to the following steps to pack the instruments which need to send out.

1. Please put the instrument for maintenance in the original packaging materials, with the related accessories.
2. Please be as specified as possible about the nature problem. Send a copy of any or all of the following information:
 - Any error messages that appeared on the power supply display.
 - Any information on the performance of the power supply.

CAUTION

- Power damage can result from using packaging materials other than those specified. Please use the special packing when shipment, and shall be carried out in accordance with the delivery of packaging standard as far as possible.
 - Never use styrene pellets in any shape as packaging materials. They do not adequately cushion the power supply or prevent it from shifting in the carton. Styrene pellets cause power damage by generating static electricity and by lodging in the rear panel.
-
3. Please pay attention to read the document preface about warranty service delivery cost in the relevant specification with the delivery.

Chapter9 Technical Specification

This chapter introduces such main technical parameters as rated voltage, rated current and rated power, usage and storage environment and temperature of the IT6400 series power supply.

Parameters		IT6411	
		High Range	Low Range
Rated values (0 °C-40 °C)	Voltage	±15V	
	Current	±3A	
	Power	45W	
	Resistance	0 - 1 Ω	
Load regulation ±(% of Output+Offset)	Voltage	≤0.01%+2mV	
	Current	≤0.05%+1mA	
Line regulation ±(% of Output+Offset)	Voltage	≤0.02%+2mV	
	Current	≤0.05%+1mA	
Setup resolution	Voltage	1mV	
	Current	0.1mA	
	OVP	10 mV	
	Resistance	1mΩ	
Readback resolution	Voltage	1mV	
	Current	5A Range	0.1mA
		5mA Range	100nA (*4)
Setup accuracy (one year、25°C±5°C) ±(% of Output+Offset)	Voltage	≤0.02%+3mV	
	Current	≤0.05%+2mA (*3)	
	OVP	0.5V (*1)	
	Resistance	≤0.1%+3mΩ	
Readback accuracy (one year、25°C±5°C) ±(% of Output+Offset)	Voltage	≤0.02%+2mV	
	5A Range	≤0.05%+2mA	
	5mA Range	≤0.05%+2uA (*4)	
Ripple (20Hz -20MHz)	Voltage	≤ 3mVp-p / 1 mV rms	
	Current	≤1mArms	
Setup Temp.coefficient (% of Output+Offset)/°C	Voltage	0.005%+0.2mV	
	Current	0.005%+0.2mA	
	OVP	0.01%+50 mV	
	Resistance	0.02%+0.5mΩ	
Readback Temp.coefficient (% of Output+Offset)/°C	Voltage	0.005%+0.2mV	
	Current	5A Range	0.005%+0.2mA
		5mA Range	0.005%+0.3 uA (*4)
Rise time (Fast mode No-load)	Voltage	≤500uS (*2)	
Rise time (Fast mode Full-load)	Voltage	≤500uS (*2)	
Fall time (Fast mode No-load)	Voltage	≤1mS (*2)	
Fall time (Fast mode Full-load)	Voltage	Change of setting value	≤500uS (*2)
	Voltage	Set output off	≤150uS (*2) (*5)
Rise time (Full-load)	Current	Fast mode	≤150uS
		Normal mode	≤10mS
Transient Response Time 50%-100% Load change	Fast mode	Recovered to 50 mV	≤50uS

Remote Sense Compensation	1V Per each lead	
Command Response Time (Typical)	5mS	
OVP Response Time	≤100uS	
Impedance of the output terminal (output off) (Typical)	Relay output Normal	150k ohms
	Relay output Battery	≥ 1 GΩ
Minimum Resistance	Sink Current Mode	≤ 0.7 Ω
Setup stability -30min (%of Output +Offset)	Voltage	0.01%+1mV
	Current	0.01%+1mA
Setup stability -8h (%of Output +Offset)	Voltage	0.01%+1.5mV
	Current	0.01%+1.5mA
Readback stability-30min (%of Output +Offset)	Voltage	0.01%+1mV
	Current	0.01%+1mA
Readback stability-8h (%of Output +Offset)	Voltage	0.01%+1.5mV
	Current	0.01%+1.5mA
AC Input	Voltage 1	110V±10%
	Voltage 2	220V±10%
	Frequency	47HZ-63HZ
Fuse specification	Voltage 1	3.15AT
	Voltage 2	1.6AT
Power Factor	0.7 Max	
Maximum input current	2A	
Maximum input apparent power	200VA	
Storage temperature	-10°C~70°C	
Protective function	OVP/OCP/OTP	
standard Interface	GPIB/USB/LAN	
Isolation (output to ground)	100Vdc	
Working temperature	0~40°C	
Dimension (mm)	226mmW*88.2mmH*476.26mmD	
Weight(net)	8Kg	
DVM		
Measurement range	-20V — +20V	
Measurement range (refer to the power supply output terminal)	Output 0V - 20V	< ±35V either input to output+
	Output -20V - 0V	< ±35V either input to output-
Display accuracy	0.02%+3mV	
Display resolution	1mV	
Display Temp.coefficient (%of Input+Offset)/°C	0.002%+0.2mV	
Display stability-30min (%of Output +Offset)	0.02%+1mV	
Display stability-8 h (%of Output +Offset)	0.02%+2 mV	
Input Common-mode voltage	< 50Vdc to ground	
Common-mode voltage rejection	≥ 80 dB	
Input impedance	4.3MΩ ± 1%	

(*1) Maximum error of OVP precision at power supply terminal under full load.

(*2) The output polarity is unchanged, the time that the power output value changes from 10% to 90%.

(*3) The Minimum value of CC setting is 2mA.

(*4) The current readback accuracy of the 5mA Range is measured under constant voltage mode.

(*5) Set output off.

Parameters		IT6411S	
Rated values (0 °C-40 °C)	Voltage	-15V-0V,0-15V	
	Current	±0.1 A	
	Power	1.5 W	
	Resistance	0-20 Ω	
Load regulation ±(% of Output+Offset)	Voltage	≤0.01%+1mV	
	Current	≤0.05%+1mA	
Line regulation ±(% of Output+Offset)	Voltage	≤0.02%+2mV	
	Current	≤0.05%+1mA	
Setup resolution	Voltage	1mV	
	Current	10uA	
	OVP	1 mV	
	Resistance	10mΩ	
Readback resolution	Voltage	1mV	
	Current	100mA Range	1uA
		100uA Range	1nA (*4)
Setup accuracy (one year, 25°C±5°C) ±(% of Output+Offset)	Voltage	≤0.02%+3mV	
	Current	≤0.05%+50uA (*3)	
	OVP	0.5V (*1)	
	Resistance	≤0.1%+50mΩ	
Readback accuracy (one year, 25°C±5°C) ±(% of Output+Offset)	Voltage	≤0.02%+2mV	
	100mA Range	≤0.05%+50uA	
	100uA Range	≤0.05%+50nA	
Ripple (20Hz -20MHz)	Voltage	≤ 3mVp-p / 1 mV rms	
	Current	≤2uArms	
Setup Temp.coefficient (% of Output+Offset)/°C	Voltage	0.01%+0.2mV	
	Current	0.01%+2uA	
	OVP	0.1%+50mV	
	Resistance	0.02%+5mΩ	
Readback Temp.coefficient (% of Output+Offset)/°C	Voltage	0.01%+0.2mV	
	Current	100mA Range	0.015%+5uA
		100uA Range	0.01%+10nA (*4)
Rise time (No-load)	Voltage	≤1mS (*2)	
Rise time (150R load)	Voltage	≤1mS (*2)	
Fall time (No-load)	Voltage	≤1S (*2)	
Fall time (150R load)	Voltage	Change of setting value	≤1mS (*2)
	Voltage	Set output off	≤0.5mS (*2)(*5)
Transient Response Time 50%-100% Load change	Fast mode	50%-100% LOAD Recovered to 50 mV	≤200uS
Remote Sense Compensation	1V Per each lead		
Command Response Time (Typical)	5mS		
OVP Response Time	≤300uS		
Impedance of the output	Relay output Normal	130k ohms	

terminal (output off) (Typical)	Relay output Battery	$\geq 1 \text{ G}\Omega$
Minimum Resistance	Sink Current Mode	$\leq 10 \Omega$
Setup stability -30min (%of Output +Offset)	Voltage	0.01%+1mV
	Current	0.01%+20uA
Setup stability -8h (%of Output +Offset)	Voltage	0.01%+1.5mV
	Current	0.01%+50uA
Readback stability-30min (%of Output +Offset)	Voltage	0.01%+1mV
	Current	0.01%+30uA
Readback stability-8h (%of Output +Offset)	Voltage	0.01%+1.5mV
	Current	0.01%+50uA
AC Input	Voltage 1	110V \pm 10%
	Voltage 2	220V \pm 10%
	Frequency	47HZ-63HZ
Fuse specification	Voltage 1	3.15AT
	Voltage 2	1.6AT
Power Factor	0.7 Max	
Maximum input current	2A	
Maximum input apparent power	80VA	
Storage temperature	-10 $^{\circ}$ C~70 $^{\circ}$ C	
Protective function	OVP/OCP/OTP	
standard Interface	GPIB/USB/LAN	
Isolation (output to ground)	100Vdc	
Working temperature	0~40 $^{\circ}$ C	
Dimension (mm)	226mmW*88.2mmH*476.26mmD	
Weight(net)	8Kg	

DVM

Measurement range	-20V — +20V	
Measurement range (refer to the power supply output terminal)	Output 0V - 15V	< \pm 20V either input to output+
	Output -15V – 0V	< \pm 20V either input to output-
Display accuracy	0.02%+3mV	
Display resolution	1mV	
Display Temp.coefficient (%of Input+Offset)/ $^{\circ}$ C	0.002%+0.2mV	
Display stability-30min (%of Output +Offset)	0.02%+1mV	
Display stability-8 h (%of Output +Offset)	0.02%+2 mV	
Input Common-mode voltage	< 100Vdc to ground	
Common-mode voltage rejection	4.5M Ω	

(*1) Maximum error of OVP precision at power supply terminal under full load.

(*2) The output polarity is unchanged, the time that the power output value changes from 10% to 90%.

(*3) The Minimum value of CC setting is 50uA.

(*4) The current readback accuracy of the 100uA Range is measured under constant voltage mode.

(*5) Set output off.

Parameters		IT6431	
Rated values (0 °C-40 °C)	Voltage	-15V-0V,0-15V	
	Current	±10 A	
	Power	150 W	
	Resistance	0 - 1 Ω	
Load regulation ±(% of Output+Offset)	Voltage	≤0.01%+3.5mV	
	Current	≤0.05%+2mA	
Line regulation ±(% of Output+Offset)	Voltage	≤0.02%+2mV	
	Current	≤0.05%+1mA	
Setup resolution	Voltage	1mV	
	Current	1mA	
	OVP	10 mV	
	Resistance	1mΩ	
Readback resolution	Voltage	1mV	
	Current	10A Range	1mA
		20mA Range	1uA
Setup accuracy (one year、25°C±5°C) ±(% of Output+Offset)	Current	≤0.02%+3mV	
	Voltage	≤0.05%+5mA (*3)	
	OVP	0.5V (*1)	
	Resistance	≤0.1%+3mΩ	
Readback accuracy (one year、25°C±5°C) ±(% of Output+Offset)	Voltage	≤0.02%+3mV	
	10A Range	≤0.05%+4mA	
	20mA Range	≤0.05%+5uA (*5)	
Ripple (20Hz -20MHz)	Voltage	≤ 4mVp-p / 1 mV rms	
	Current	≤5mArms	
Setup Temp.coefficient (% of Output+Offset)/°C	Voltage	0.005%+0.4mV	
	Current	0.015%+0.3mA	
	OVP	0.01%+50 mV	
	Resistance	0.02%+0.5mΩ	
Readback Temp.coefficient (% of Output+Offset)/°C	Voltage	0.005%+0.3mV	
	Current	10A Range	0.015%+0.2mA
		20mA Range	0.005%+0.5 uA (*5)
Rise time (Fast mode No-load)	Voltage	≤150uS (*2)	
Rise time (Fast mode Full-load)	Voltage	≤150uS (*2)	
Fall time (Fast mode No-load)	Voltage	≤150uS (*2) (*4)	
Fall time (Fast mode Full-load)	Voltage	Change of setting value	≤150uS (*2)
		Set output off	≤50uS (*2) (*6)
Rise time (Full-load)	Current	Fast mode	≤150uS
		Normal mode	≤10mS
Transient Response Time 50%-100% Load change	Fast mode 50%-100% LOAD	Recovered to 50 mV	≤30uS
Remote Sense Compensation	1V Per each lead		
Command Response Time (Typical)	5mS		
OVP Response Time	≤80uS		
Impedance of the output terminal (output off) (Typical)	Relay output Normal	130k ohms	
	Relay output Battery	≥ 1 GΩ	
Minimum Resistance	Sink Current Mode	≤ 0.3 Ω	

Setup stability -30min (%of Output +Offset)	Voltage	0.01%+1mV	
	Current	0.01%+2mA	
Setup stability -8h (%of Output +Offset)	Voltage	0.01%+1.5mV	
	Current	0.01%+3mA	
Readback stability-30min (%of Output +Offset)	Voltage	0.01%+1mV	
	Current	10A Range	0.01%+2mA
	Voltage	20mA Range	0.01%+3uA (*5)
Readback stability-8h (%of Output +Offset)	Current	0.01%+1.5mV	
	Voltage	10A Range	0.01%+3mA
		20mA Range	0.01%+4uA (*5)
AC Input	Voltage 1	110V±10%	
	Voltage 2	220V±10%	
	Frequency	47HZ-63HZ	
Fuse specification	Voltage 1	5A	
	Voltage 2	2.5A	
Power Factor	0.7 Max		
Maximum input current	5A		
Maximum input apparent power	500VA		
Storage temperature	-10°C~70°C		
Protective function	OVP/OCP/OTP/RVP		
standard Interface	GPIB/USB/LAN		
Isolation (output to ground)	100Vdc		
Working temperature	0~40°C		
Dimension (mm)	226mmW*88.2mmH*476.26mmD		
Weight(net)	8Kg		
DVM			
Measurement range	-20V — +20V		
Measurement range (refer to the power supply output terminal)	Output 0V - 15V	< ±35V either input to output+	
	Output -15V – 0V	< ±35V either input to output-	
Display accuracy	0.02%+3mV		
Display resolution	1mV		
Display Temp.coefficient (%of Input+Offset)/°C	0.002%+0.2mV		
Display stability-30min (%of Output +Offset)	0.02%+1mV		
Display stability-8 h (%of Output +Offset)	0.02%+2 mV		
Input Common-mode voltage	< 100Vdc to ground		
Common-mode voltage rejection	≥ 80 dB		
Input impedance	4.5MΩ		

(*1) Maximum error of OVP precision at power supply terminal under full load.

(*2) Under Fast mode, the output polarity is unchanged, the time that the power output value changes from 10% to 90%.

(*3) The Minimum value of CC setting is 10mA.

(*4) The voltage setting value will change to 0V under power supply output is 15V.

(*5) The current readback accuracy of the 20mA Range is measured under constant voltage mode.

(*6) Set output off.

Parameters		IT6432	
Rated values (0 °C-40 °C)	Voltage	-30V-0V,0-30V	
	Current	±5 A	
	Power	150 W	
	Resistance	0 - 1 Ω	
Load regulation ±(%of Output+Offset)	Voltage	≤0.01%+2mV	
	Current	≤0.05%+1mA	
Line regulation ±(%of Output+Offset)	Voltage	≤0.02%+2mV	
	Current	≤0.05%+1mA	
Setup resolution	Voltage	1mV	
	Current	0.1mA	
	OVP	10 mV	
	Resistance	1mΩ	
Readback resolution	Voltage	1mV	
	Current	5A Range	0.1mA
		5mA Range	100nA
Setup accuracy (one year、25°C±5°C) ±(%of Output+Offset)	Voltage	≤0.02%+3mV	
	Current	≤0.05%+3mA (*3)	
	OVP	0.5V (*1)	
	Resistance	≤0.1%+3mΩ	
Readback accuracy (one year、25°C±5°C) ±(%of Output+Offset)	Voltage	≤0.02%+3mV	
	5A Range	≤0.05%+3mA	
	5mA Range	≤0.05%+2uA (*5)	
Ripple (20Hz -20MHz)	Voltage	≤ 4mVp-p / 1 mV rms	
	Current	≤1mArms	
Setup Temp.coefficient (%of Output+Offset)/°C	Voltage	0.005%+0.4mV	
	Current	0.01%+0.2mA	
	OVP	0.01%+50 mV	
	Resistance	0.02%+0.5mΩ	
Readback Temp.coefficient (%of Output+Offset)/°C	Voltage	0.005%+0.3mV	
	Current	5A Range	0.015%+0.1mA
		5mA Range	0.005%+0.3 uA (*5)
Rise time (Fast mode No-load)	Voltage	≤150uS (*2)	
Rise time (Fast mode Full-load)	Voltage	≤150uS (*2)	
Fall time (Fast mode No-load)	Voltage	≤150uS (*2) (*4)	
Fall time (Fast mode Full-load)	Voltage	Change of setting value	≤150uS (*2)
		Set output off	≤50uS (*2) (*6)
Rise time (Full-load)	Current	Fast mode	≤150uS
		Normal mode	≤10mS
Transient Response Time 50%-100% Load change	Fast mode	50%-100% LOAD	Recovered to 50 mV ≤30uS
Remote Sense Compensation	1V Per each lead		
Command Response Time (Typical)	5mS		
OVP Response Time	≤80uS		
Impedance of the output terminal (output off) (Typical)	Relay output	Normal	200k ohms
	Relay output	Battery	≥ 1 GΩ

Minimum Resistance	Sink Current Mode		$\leq 0.7 \Omega$
Setup stability -30min (%of Output +Offset)	Voltage	0.01%+1mV	
	Current	0.01%+1mA	
Setup stability -8h (%of Output +Offset)	Voltage	0.01%+1.5mV	
	Current	0.01%+1.5mA	
Readback stability-30min (%of Output +Offset)	Voltage	0.01%+1mV	
	Current	5A Range	0.01%+1mA
	Voltage	5mA Range	0.01%+2 μ A (*5)
Readback stability-8h (%of Output +Offset)	Current	0.01%+1.5mV	
	Voltage	5A Range	0.01%+1.5mA
		5mA Range	0.01%+3 μ A (*5)
AC Input	Voltage 1	110V \pm 10%	
	Voltage 2	220V \pm 10%	
	Frequency	47HZ-63HZ	
Fuse specification	Voltage 1	5A	
	Voltage 2	2.5A	
Power Factor	0.7 Max		
Maximum input current	5A		
Maximum input apparent power	500VA		
Storage temperature	-10 $^{\circ}$ C~70 $^{\circ}$ C		
Protective function	OVP/OCP/OTP/RVP		
standard Interface	GPIB/USB/LAN		
Isolation (output to ground)	100Vdc		
Working temperature	0~40 $^{\circ}$ C		
Dimension (mm)	226mmW*88.2mmH*476.26mmD		
Weight(net)	8Kg		
DVM			
Measurement range	-30V — +30V		
Measurement range (refer to the power supply output terminal)	Output 0V - 30V	< \pm 35V either input to output+	
	Output -30V – 0V	< \pm 35V either input to output-	
Display accuracy	0.02%+3mV		
Display resolution	1mV		
Display Temp.coefficient (%of Input+Offset)/ $^{\circ}$ C	0.002%+0.2mV		
Display stability-30min (%of Output +Offset)	0.02%+1mV		
Display stability-8 h (%of Output +Offset)	0.02%+2 mV		
Input Common-mode voltage	< 100Vdc to ground		
Common-mode voltage rejection	≥ 80 dB		
Input impedance	4.5M Ω		

(*1) Maximum error of OVP precision at power supply terminal under full load.

(*2) Under Fast mode, the output polarity is unchanged, the time that the power output value changes from 10% to 90%.

(*3) The Minimum value of CC setting is 2mA.

(*4) The voltage setting value will change to 0V under power supply output is 30V.

(*5) The current readback accuracy of the 20mA Range is measured under constant voltage mode.

(*6) Set output off.

Parameters		IT6433	
Rated values (0 °C-40 °C)	Voltage	-60V-0V,0-60V	
	Current	±2.5 A	
	Power	150 W	
	Resistance	0 - 1 Ω	
Load regulation ±(% of Output+Offset)	Voltage	≤0.01%+2mV	
	Current	≤0.05%+1mA	
Line regulation ±(% of Output+Offset)	Voltage	≤0.02%+2mV	
	Current	≤0.05%+1mA	
Setup resolution	Voltage	1mV	
	Current	0.1mA	
	OVP	10 mV	
	Resistance	1mΩ	
Readback resolution	Voltage	1mV	
	Current	2.5A Range	0.1mA
		5mA Range	100nA
Setup accuracy (one year, 25°C±5°C) ±(% of Output+Offset)	Current	≤0.02%+4mV	
	Voltage	≤0.05%+2mA (*3)	
	OVP	0.5V (*1)	
	Resistance	≤0.1%+3mΩ	
Readback accuracy (one year, 25°C±5°C) ±(% of Output+Offset)	Voltage	≤0.02%+4mV	
	2.5A Range	≤0.05%+2mA	
	5mA Range	≤0.05%+2uA (*5)	
Ripple (20Hz -20MHz)	Voltage	≤ 5mVp-p / 1 mV rms	
	Current	≤1mArms	
Setup Temp.coefficient (% of Output+Offset)/°C	Voltage	0.005%+0.5mV	
	Current	0.01%+0.2mA	
	OVP	0.01%+60 mV	
	Resistance	0.02%+0.5mΩ	
Readback Temp.coefficient (% of Output+Offset)/°C	Voltage	0.005%+0.4mV	
	Current	2.5A Range	0.015%+0.1mA
		5mA Range	0.005%+0.3 uA (*5)
Rise time (Fast mode No-load)	Voltage	≤200uS (*2)	
Rise time (Fast mode Full-load)	Voltage	≤200uS (*2)	
Fall time (Fast mode No-load)	Voltage	≤200uS (*2)	
Fall time (Fast mode Full-load)	Voltage	Change of setting value	≤200uS (*2)
		Set output off	≤100uS (*2)
Rise time (Full-load)	Current	Fast mode	≤200uS
		Normal mode	≤10mS
Transient Response Time 50%-100% Load change	50%-100% LOAD	Recovered to 50 mV	≤20uS
Remote Sense Compensation	1V Per each lead		
Command Response Time (Typical)	5mS		
OVP Response Time	≤80uS		
Impedance of the output terminal	Relay output Normal	400k ohms	
	Relay output Battery	≥ 1GΩ	

(output off) (Typical)			
Minimum Resistance	Sink Current Mode $\leq 1 \Omega$		
Setup stability -30min (%of Output +Offset)	Voltage	0.01%+1mV	
	Current	0.01%+1mA	
Setup stability -8h (%of Output +Offset)	Voltage	0.01%+2mV	
	Current	0.01%+1.5mA	
Readback stability-30min (%of Output +Offset)	Voltage	0.01%+1mV	
	Current	5A Range	0.01%+1mA
	Voltage	5mA Range	0.01%+2uA (*5)
Readback stability-8h (%of Output +Offset)	Current	0.01%+2mV	
	Voltage	5A Range	0.01%+1.5mA
		5mA Range	0.01%+3uA (*5)
AC Input	Voltage 1	110V \pm 10%	
	Voltage 2	220V \pm 10%	
	Frequency	47HZ-63HZ	
Fuse specification	Voltage 1	5A	
	Voltage 2	2.5A	
Power Factor	0.7 Max		
Maximum input current	5A		
Maximum input apparent power	500VA		
Storage temperature	-10 $^{\circ}$ C~70 $^{\circ}$ C		
Protective function	OVP/OCP/OTP/RVP		
standard Interface	GPIB/USB/LAN		
Isolation (output to ground)	100Vdc		
Working temperature	0~40 $^{\circ}$ C		
Dimension (mm)	226mmW*88.2mmH*476.26mmD		
Weight(net)	8Kg		
DVM			
Measurement range	-60V — +60V		
Measurement range (refer to the power supply output terminal)	Output 0V - 60V	< \pm 65V either input to output+	
	Output -60V – 0V	< \pm 65V either input to output-	
Display accuracy	0.02%+5mV		
Display resolution	1mV		
Display Temp.coefficient (%of Input+Offset)/ $^{\circ}$ C	0.002%+0.3mV		
Display stability-30min (%of Output +Offset)	0.02%+1mV		
Display stability-8 h (%of Output +Offset)	0.02%+2 mV		
Input Common-mode voltage	< 100Vdc to ground		
Common-mode voltage rejection	≥ 80 dB		
Input impedance	4M Ω		

(*1) Maximum error of OVP precision at power supply terminal under full load.

(*2) Under Fast mode, the output polarity is unchanged, the time that the power output value changes from 10% to 90%.

(*3) The Minimum value of CC setting is 2mA.

(*4) The voltage setting value will change to 0V under power supply output is 60V.

(*5) The current readback accuracy of the 5mA Range is measured under

constant voltage mode.

(*6) Set output off.

*The above specifications may be subject to change without prior notice.

Chapter10 Remote Operation Mode

IT6400 series power supply is provided with three communication interfaces to communicate with a computer for selection, including USB, LAN and GPIB.

10.1 USB Interface

Use cables with double USB interface to connect power and PC. All power functions are programmable over the USB.

The USB488 interface capabilities of the power are described below:

- The interface is 488.2 USB488 interface.
- The interface accepts REN_CONTROL, GO_TO_LOCAL, and LOCAL_LOCKOUT requests.
- The interface accepts MsgID = TRIGGER USBTMC command message and forwards TRIGGER requests to the function layer.

The USB488device capabilities of the power are described below:

- The device understands all mandatory SCPI commands.
- The device is SR1 capable.
- The device is RL1 capable.
- The device is DT1 capable.

10.2 GPIB Interface

First connect GPIB port of power to GPIB card of PC with IEEE488 BUS. They must be sufficient contact and tighten the screws. And then set address. The address can be set from 1 to 30.

Select "**Menu > System > Sys Com**" to enter Communication Configuration page. Select GPIB by pressing arrow keys, and then set the GPIB address, press [OK] to confirm. The power operates from a GPIB address set from the front panel. The GPIB address is stored in non-volatile memory.

10.3 LAN Interface

Select "**Menu > System > Sys Com**" to enter communication configuration page. Select LAN by pressing arrow keys and then configure Gateway, IP, Mask and Socket Port in the LAN option. Use a cross network cable through LAN interface to connect PC.

Appendix

Specifications of Red and Black Test Lines

ITECH provides you with optional red and black test cables, which individual sales and you can select for test. For specifications of ITECH test cables and maximum current values, refer to the table below.

Model	Specification	Length	Description
IT-E30110-AB	10A	1m	A pair of red and black test cables with an alligator clip at one end and a banana plug at the other end
IT-E30110-BB	10A	1m	A pair of red and black test cables with banana plugs at both ends
IT-E30110-BY	10A	1m	A pair of red and black test cables with a banana plug at one end and a Y-terminal at the other end
IT-E30312-YY	30A	1.2m	A pair of red and black test cables with Y-terminals at both ends
IT-E30320-YY	30A	2m	A pair of red and black test cables with Y-terminals at both ends
IT-E30615-OO	60A	1.5m	A pair of red and black test cables with round terminals at both ends
IT-E31220-OO	120A	2m	A pair of red and black test cables with round terminals at both ends
IT-E32410-OO	240A	1m	A pair of red and black test cables with round terminals at both ends
IT-E32420-OO	240A	2m	A pair of red and black test cables with round terminals at both ends
IT-E33620-OO	360A	2m	A pair of red and black test cables with round terminals at both ends

For maximum current of AWG copper wire, refer to table below.

AWG	10	12	14	16	18	20	22	24	26	28
The Maximum current value(A)	40	25	20	13	10	7	5	3.5	2.5	1.7

Note: AWG (American Wire Gage), it means X wire (marked on the wire). The table above lists current capacity of single wire at working temperature of 30°C. For reference only.

Contact US

Thank you for purchasing ITECH products. If you have any doubt about this product, please contact us as follow.

1. Please refer to the CD-ROM of related user's manual in package.
2. Visit ITECH website www.itechate.com.
3. Select the most convenient contact for further consultation.