

Programmable DC Electronic Load

Series IT8800 User's Manual

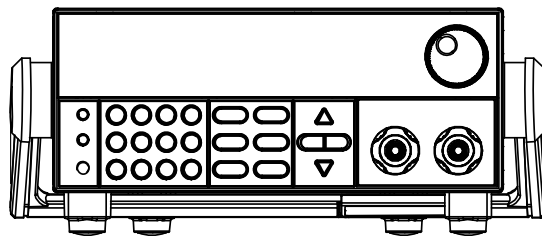

Model:IT8811/IT8812/IT8812B/IT8812C
Revision: V2.6

Statement

According to the international copyright law, reproduction of any part of this manual in any form (including electronic storage and retrieval or translation into languages of other countries or regions) is not allowed without prior permission and written consent of Itech Electronic Co., Ltd.

Manual Article No.

IT8800-402180

Revision

Revision 2, published on

April 28, 2019

Itech Electronic, Co., Ltd.

Trademark Statement

Pentium is a registered trademark of Intel Corporation in the United States.

Microsoft, Visual Studio, Windows and MS Windows are trademarks of Microsoft Corporation in the United States and/or other countries/regions.

Guarantee

Materials in the document are provided *talīs qualīs* and may be changed in future revisions without prior notice. In addition, within the maximum allowable extent of laws, ITECH is not committed to any explicit or implied guarantee for this manual and all information therein, including but not limited to the implied guarantee on marketability and availability for some special purposes. ITECH shall not be responsible for any error or incidental or indirect losses caused by the provision, use or application of this documents and information therein. If some guarantee clauses in other written agreements between ITECH and users are not consistent with clauses herein, those clauses in other written agreements shall prevail.

Technology license

Hardware and/or software in this document cannot be provided without a license and can only be used or copied according to the license.

Restricted permission statement

Restricted permissions of the U.S. government. Permissions for software and technical data which are authorized to the U.S. Government only include those for custom provision to end users. ITECH follows FAR 12.211 (technical data), 12.212 (computer software). DFARS 252.227-7015 (technical data--commercial products) for national defense and DFARS 227.7202-3 (permissions for commercial computer software or computer software documents) while providing the customized business licenses of software and technical data.

Safety Statement

CAUTION

“Caution” signs indicate danger. It is required to pay attention to the contents of these signs during implementation of operations.

The damage to the product or loss of important data may be caused in case of improper operation steps or failure to follow operation steps. Do not continue to implement any improper operation indicated in “Caution” signs when the specified conditions are not fully understood or these conditions are not satisfied.

WARNING

“Warning” indicates danger. It is required to pay attention to the contents of these signs during implementation of operation steps. Personal casualties may be caused in case of improper operation steps or failure to follow these operation steps. Do not continue to implement any improper operation indicated in “Warning” signs when the specified conditions are not fully understood or these conditions are not satisfied.



NOTE

“Instructions” indicates operation instructions. It is required to refer to the contents of these signs during operation steps. These signs are used for providing tips or supplementary information for operators.

Certification and Quality Assurance

IT8800 series electronic load completely reaches nominal technical indicators in the manual.

Warranty service

ITECH Company will provide one-year warranty services for the product materials and manufacturing (excluding the following limitations).















- When warranty service or repair is needed, please send the product to the service unit specified by ITECH Company.
- When the product is sent to ITECH Company for warranty service, the customer must pay the one-way freight to the maintenance department of ITECH, and ITECH will be responsible for return freight.
- If the product is sent to ITECH for warranty service from other countries, the customer will be responsible for all the freight, duties and other taxes.

Limitation of Warranty

Warranty service does not apply to the damage caused in the following circumstances:

- Damage resulting from customer-wired circuits or customer-supplied parts or accessories;
- Product which has been modified or repaired by the customer;
- Damage caused by the circuit installed by the customer or damage caused by operation of the product in non-specified environment;
- The product model or serial number is altered, deleted, removed or made illegible by customer;
- Damage caused by accidents, including but not limited to lightning, water, fire, abuse or negligence.

Safety signs

	DC power		ON (with the power switched on)
	AC power		OFF (with the power supply switched off)
	Both DC and AC power supply		Power supply switching-on status
	Protective grounding terminal		Power supply switching-off status
	Grounding terminal		Reference terminal
	Danger sign		Positive terminal
	Warning sign (refer to specific "Warning" or "Caution" information in the manual)		Negative terminal
	Ground wire connection end sign	-	-

Safety Precautions

General safety precautions below must be followed in each phase of instrument operation. In case of failure to follow these precautions or specific warnings in other parts of the manual, violation against the safety standards related to the design, manufacture and purpose of the instrument will occur. If the user does not follow these precautions, ITECH will bear no responsibility arising there from.

WARNING

- Working voltage of IT8800 series includes 110V/220V. To prevent burnout, be sure to check whether the AC voltage setting of electronic load is consistent to the supply voltage before start-up!
- The electronic load is provided with a three-core power line during delivery and should be connected to a three-core junction box. Before operation, be sure that the electronic load is well grounded.
- Use electric wires of appropriate load. All loading wires should be capable of bearing maximum short-circuit of electronic load without overheating.
- Ensure the voltage fluctuation of mains supply is less than 10% of the working voltage range in order to reduce risks of fire and electric shock.
- To prevent burnout, please pay special attention to positive and negative polarities of electronic load during connection!
- Do not use damaged equipment. Please check the housing before using the equipment. Check whether the instrument is subject to cracking or is lack of plastic. Do not operate the instrument in the environment with explosive gas, steam or dust.
- Observe all tags on the equipment before connection.
- Do not install alternative parts on the instrument or perform any unauthorized modification.
- Do not use the equipment when the removable cover is dismantled or loose.
- Please use the power adapter supplied by the manufacturer to avoid accidental injury.
- We do not accept responsibility for any direct or indirect financial damage or loss of profit that might occur when using the instrument.
- This instrument is used for industrial purposes. Do not apply this product to IT power supply system.
- Do not use the equipment on the life support system or other equipment with safety requirements.

CAUTION

- If the equipment is not used in the manner specified by the manufacturer, its protection may be damaged.
- Always use dry cloth to clean the equipment housing. Do not clean the inside of the instrument.
- Do not block the air vent of the equipment.

Environmental conditions

The IT8800 series electronic load can only be used indoors or in low condensation areas. The following table shows general environmental requirements for this instrument.



Environmental conditions	Requirement
--------------------------	-------------

Operating temperature	0°C~40°C 0°C - 40°C
Operating humidity	20% - 80% (non condensing)
Storage temperature	-20°C - 70 °C
Altitude	Operating up to 2,000 meters
Installation category	II
Pollution degree	Pollution degree 2

NOTE

In order to ensure the accuracy of measurement, it is recommended to operate the instrument half an hour after start-up.

Regulation tag

	The CE tag shows that the product complies with the provisions of all relevant European laws (if the year is shown, it indicates that the year when the design is approved).
	This instrument complies with the WEEE directive (2002/96/EC) tag requirements. This attached product tag shows that the electrical/electronic product cannot be discarded in household waste.
	This symbol indicates that no danger will happen or toxic substances will not leak or cause damage in normal use within the specified period. The service life of the product is 10 years. The product can be used safely within the environmental protection period; otherwise, the product should be put into the recycling system.

Waste electrical and electronic equipment (WEEE) directive



Waste electrical and electronic equipment (WEEE) directive, 2002/96/EC

The product complies with tag requirements of the WEEE directive (2002/96/EC). This tag indicates that the electronic equipment cannot be disposed of as ordinary household waste.

Product Category

According to the equipment classification in Annex I of the WEEE directive, this instrument belongs to the "Monitoring" product.

If you want to return the unnecessary instrument, please contact the nearest sales office of ITECH.

Compliance Information

Complies with the essential requirements of the following applicable European Directives, and carries the CE marking accordingly:

- Electromagnetic Compatibility (EMC) Directive 2014/30/EU
- Low-Voltage Directive (Safety) 2014/35/EU

Conforms with the following product standards:

EMC Standard

IEC 61326-1:2012/ EN 61326-1:2013 ¹²³

Reference Standards

CISPR 11:2009+A1:2010/ EN 55011:2009+A1:2010 (Group 1, Class A)

IEC 61000-4-2:2008/ EN 61000-4-2:2009

IEC 61000-4-3:2006+A1:2007+A2:2010/ EN 61000-4-3:2006+A1:2008+A2:2010

IEC 61000-4-4:2004+A1:2010/ EN 61000-4-4:2004+A1:2010

IEC 61000-4-5:2005/ EN 61000-4-5:2006

IEC 61000-4-6:2008/ EN 61000-4-6:2009

IEC 61000-4-11:2004/ EN 61000-4-11:2004

1. The product is intended for use in non-residential/non-domestic environments. Use of the product in residential/domestic environments may cause electromagnetic interference.
2. Connection of the instrument to a test object may produce radiations beyond the specified limit.
3. Use high-performance shielded interface cable to ensure conformity with the EMC standards listed above.

Safety Standard

IEC 61010-1:2010/ EN 61010-1:2010

Content

Certification and Quality Assurance.....	iii
Warranty service.....	iii
Limitation of Warranty.....	iii
Safety signs.....	iii
Safety Precautions.....	iv
Environmental conditions.....	iv
Regulation tag.....	v
Waste electrical and electronic equipment (WEEE) directive.....	v
Compliance Information.....	vi
Chapter1 Acceptance and Installation.....	1
1.1 Confirm package contents.....	1
1.2. Installation position.....	1
1.3 Adjustment of load handle.....	2
1.4 Disassembly of load handle.....	3
1.5 Installation of support.....	3
1.6 Connecting the DUT.....	3
1.7 Connecting the Power Line.....	4
Chapter2 Quick Start.....	6
2.1 Brief Introduction.....	6
2.2 Introduction of front board.....	7
2.3 Introduction of keyboard.....	7
2.4 Fast function key.....	8
2.5 Function description of VFD status indicators.....	8
2.6 Introduction of rear board.....	9
2.7 Power-on selftest.....	9
Chapter3 Function and Features.....	12
3.1 Switching of local/remote operation modes.....	12
3.2 Constant-status operation mode.....	12
3.2.1 Constant current operation mode (CC).....	12
3.2.2 Constant voltage operation mode (CV).....	14
3.2.3 Constant resistance operation mode (CR).....	15
3.2.4 Constant power operation mode (CW).....	16
3.3 Input control function.....	17
3.4 Keyboard locking function.....	17
3.5 Short-circuit analog function.....	17
3.6 System menu function.....	17
3.7 Configuration menu function.....	18
3.8 Triggering function.....	19
3.9 Dynamic test function.....	20
3.9.1 Continuous mode.....	20
3.9.2 Pulse mode.....	21
3.9.3 Toggle mode.....	22
3.10 OCP test function.....	24
3.11 OPP test function.....	25
3.12 Battery discharge test function.....	26
3.13 CR-LED test function.....	27
3.14 Measurement of voltage rise time.....	27
3.15 Configuration save function.....	28
3.16 VON function.....	28
3.17 Protective function.....	29
3.17.1 Overvoltage protection (OVP).....	29
3.17.2 Overcurrent protection (OCP).....	30
3.17.3 Overpower protection (OPP).....	30
3.17.4 Overtemperature protection (OTP).....	30
3.18 List operation.....	31
3.19 Terminal function of rear board.....	33
3.19.1 Remote sense compensation functions.....	33
3.19.2 External trigger function.....	34

3.19.3 External analog quantity test	34
3.19.4 Voltage fault indication	34
3.19.5 External On/Off Control	34
3.19.6 Current monitoring (I Monitor).....	34
3.20 External Signal Control Interface	35
3.21 Auto test function	35
Chapter4 Technical Specification.....	39
4.1 Specification.....	39
4.2 Supplementary characteristic.....	41
Chapter5 References of Load Communication Interfaces	42
5.1 RS232 interface	42
5.2 USB Interface	43
5.3 GPIB interface	43
Appendix.....	44
Specifications of Red and Black Test Lines	44

Chapter1 Acceptance and Installation

1.1 Confirm package contents

Open the package and check the articles within package box before operation. In case of any non-conformity, missing or appearance wearing, please contact ITECH immediately.

The package box should comprise:

Device name	Quantity	Model	Remarks
Electronic load	1	IT8800 series	IT8800 series include: IT8811/IT8812/IT8812B/IT8812C
Power line	1	IT-E171/IT-E172/ IT-E173/IT-E174	The User may select different power lines based on local outlet specification. For detailed specifications, refer to 1.7 Connecting the Power Line.
CD	1	-	Comprising user manual and documents related to programming and grammatical guidelines.
Factory alignment report	1	-	Test report before delivery.
USB communication line	1	-	-



NOTE

After confirming that package contents are consistent and correct, please appropriately keep package box and related contents. The package requirements should be met when the instrument is returned to factory for repair.

IT8800 Series load is supplied with the following optional accessories (sold separately):

Item	Model	Remarks
Rack mount kit	IT-E151/ IT-E151A	To mount the instrument on a special rack, user may select this optional.

1.2. Installation position

The instrument should be installed at well-ventilated and rational-sized space. Please select appropriate space for installation based on the electronic load size.

Model: IT8811/IT8812/IT8812B/IT8812C

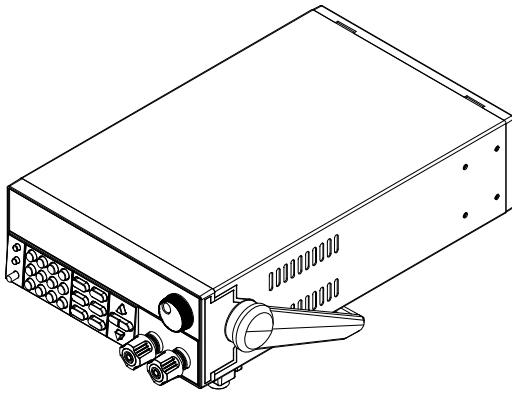

Detailed dimensional drawings

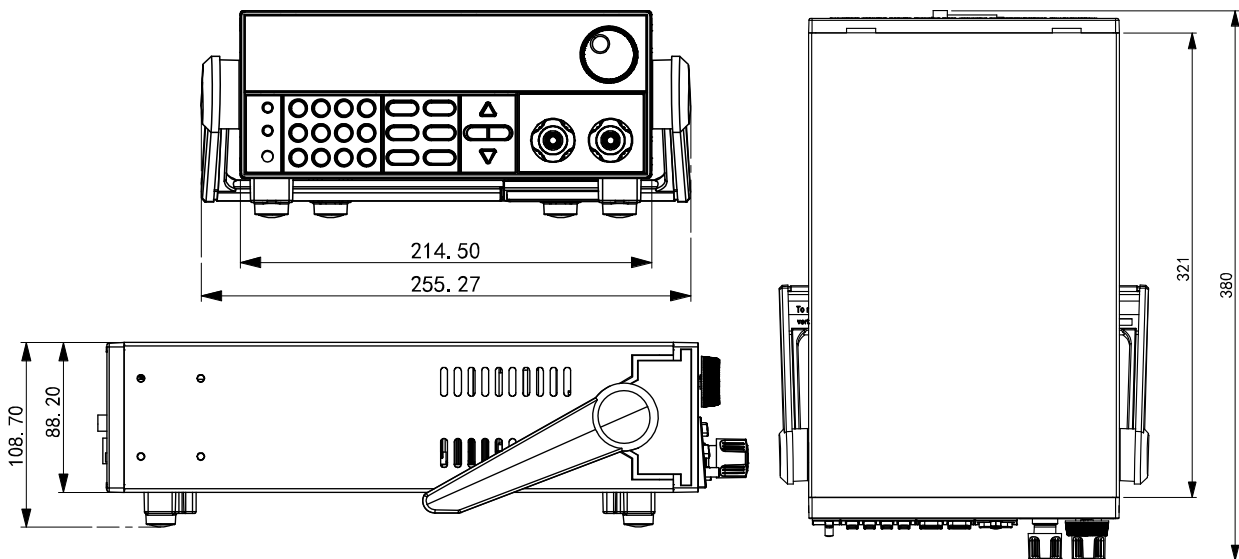

1.3 Adjustment of load handle

The load handle may be adjusted based on three methods (as shown in icons below). Be sure that appropriate force is applied to adjust the load handle to appropriate position.

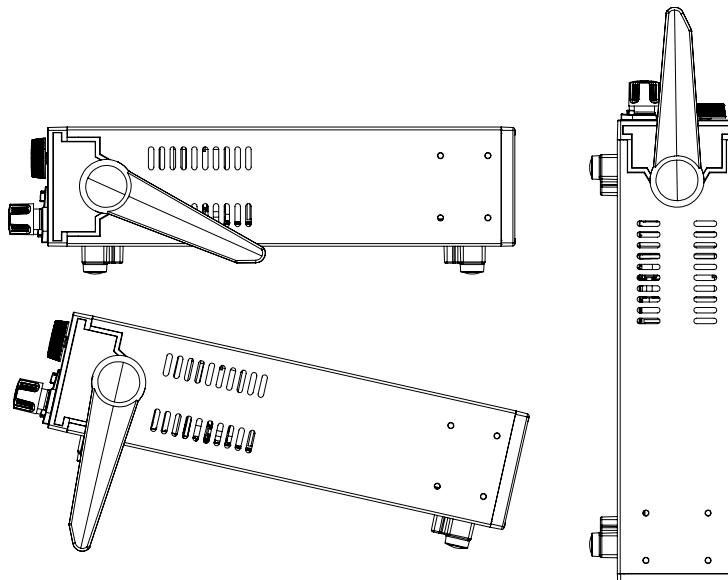

1.4 Disassembly of load handle

Please disassemble the load handle before installing equipment on the support.
Disassembly steps:

1. Adjust the handle to the position as shown in the figure below.

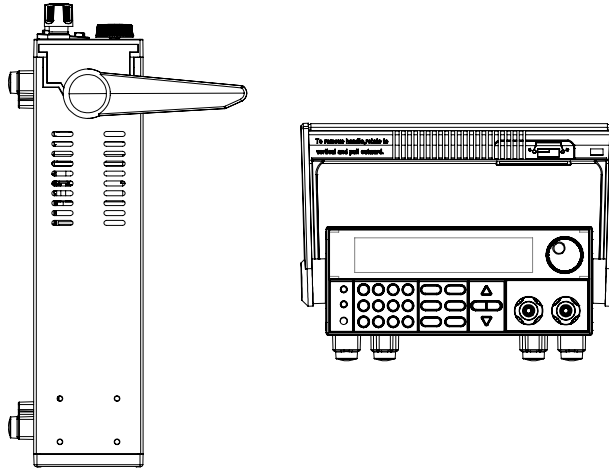

NOTE

To easily disassemble handle, align the locking mouth and locking device, which is between the handle and the instrument.

2. Align the locking mouth, and pull out the handle towards two sides.



NOTE

Do not use too much force and mind your hands during disassembly of load handle.

1.5 Installation of support

IT8800 Series load can be mounted on a standard 19" rack. ITECH provides user with IT-E151/IT-E151A rack, as an optional mount kit. The detailed operation please refer to the User Manual of your mount kit.

1.6 Connecting the DUT

Before connecting the DUT

Test lines are not standard accessories of the instrument. Please select optional red and black test lines for individual sales based on the maximum current value. For specifications of test lines and maximum current values, refer to "**Specifications of Red and Black Test Lines**" in "**Appendix**".

WARNING

- Before connecting DUT, be sure to switch off the power supply of the test loop in order to avoid electric shock.
- To avoid electrical shock, before testing, please make sure the rating values of the testing lines, and do not measure the current that higher than the rating value.
- Always use test lines provided by ITECH to connect the equipment. If test lines from other factories are used, please check

that the test line can withstand maximum current.

Introduction of Binding Posts

The maximum rated current of the terminal at position (A) is the maximum rated input current of the instrument. Securely fasten all wires by hand-tightening the binding posts. You can also insert standard banana plugs into the front of the connectors as shown in (B), and the maximum rated current at (B) is 10 A.

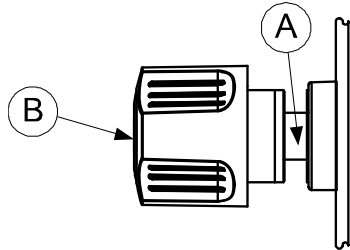

Connecting the DUT

Test line connection is given below taking local measurement as example. For details of local and remote measurements, refer to “**Terminal function of rear board**”.

1. Before connecting the test lines, be sure that the instrument Power is in Off position.
2. Unscrew the screws of the input terminals and connect the red and black test lines to the input terminals. Re-tighten the screws.

When maximum current that one test line can withstand fails to meet the current rated current, use several pieces of red and black test lines. For example, the maximum current is 1,200A, then 4 pieces of 360A red and black lines are required.

3. Directly connect the other end of the red and black lines to the DUT terminal.

1.7 Connecting the Power Line

Connect power line of standard accessories and ensure that the electronic load is under normal power supply.

AC power input level

Working voltage of IT8811/IT8812/IT8812B/IT8812C includes 110V and 220V(which can be selected by the switch on rear board of load).

AC power input level:

- Option Opt.1: 220Vac 50Hz/60Hz
- Option Opt.2: 110Vac 50Hz/60Hz

Categories of power lines

Please select appropriate power lines appropriate to local voltage based on the specifications of power lines below. If purchased model fails to meet local voltage requirements, please contact distributor or factory for change.

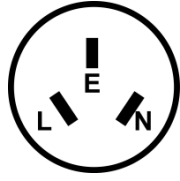

China
IT-171

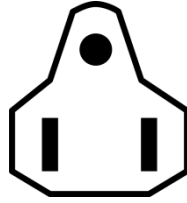

America, Canada,
Japan
IT-E172

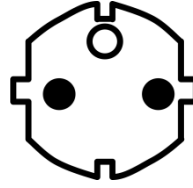

Europe
IT-E173

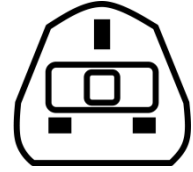

Britain
IT-E174

Chapter2 Quick Start

This Chapter will introduce power-on check steps of IT8800 Series to ensure normal start-up and usage under initialization status of the load. Besides, to facilitate usage, this part also displays the functions of front board, rear board and keyboard keys as well as display functions of VFD (Vacuum Fluorescent Display) to a quick view of load appearance, structure and key usage functions before operation.

2.1 Brief Introduction

IT8800 Series is a single-input programmable DC electronic load. Built in with RS232, USB and GPIB communication interfaces, this series of programmable DC electronic load provides a multi-purpose solution to meet different design and test requirements.

This Series delivers special functions and advantages at international level, including:

- High-visibility vacuum fluorescent display (VFD)
- Dynamic mode: up to 25KHz
- Voltage measurement dissolution rate: up to 0.1 mV Current 0.01 mA (10 uA)
- Voltage and current measurement speed: up to 50 KHz
- Four operation modes: constant voltage, constant current, constant resistance and constant power.
- Rotary coding switch for easy and quick operation
- Remote sense test function
- Battery test function
- OCP test, OPP test
- Auto test function
- CR-LED test
- Memory capacity: 100 groups
- Short-circuit function
- Dynamic test function
- Portable and robust enclosure equipped with skid resistant foot stand
- Intelligent fan control
- Built-in Buzzer, for warning
- Outage backup memory
- Built-in GPIB, USB and RS232 communication interfaces

Model	Voltage	Current	Power
IT8811	120V	30A	150W
IT8812	120V	30A	250W
IT8812B	500V	15A	200W
IT8812C	120V	60A	250W

2.2 Introduction of front board

IT8800 Series front board:

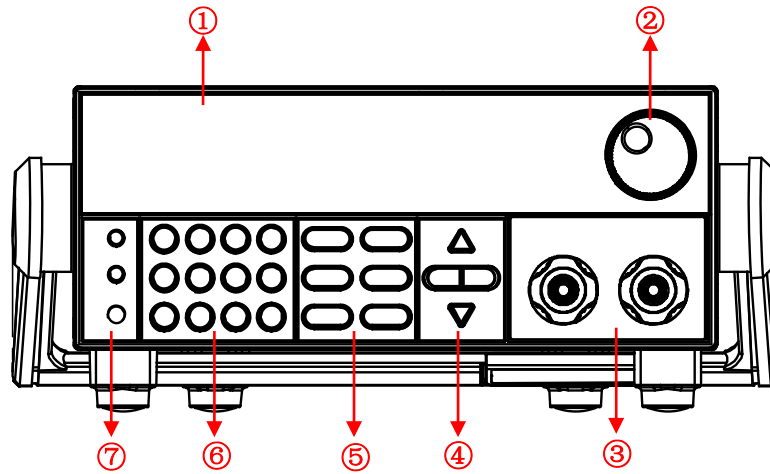







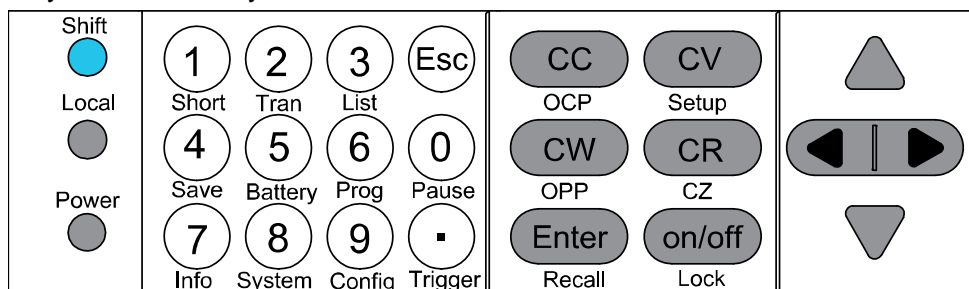

1. VFD screen
2. Adjusting knob
3. Input terminal
4. UP, DOWN, LEFT and RIGHT key, to move cursor
5. Function keys
6. Numeric keys and Esc keys
7. Compound key, the local switch key and power switch







2.3 Introduction of keyboard

Keys at IT8800 key area are shown below.





































Detailed description of keys:

	Shift composite key.
	LOCAL key, to shift local and remote operation.
	Power on key.
	0 -9 are numeric keys.
	Dot.
	Esc key, to exit at any working status.
	To select constant current mode and set current input value.
	To select constant voltage mode and set voltage input value.
	To select constant resistance mode and set resistance input value.

	To select constant power mode and set constant power input value.
	Enter key.
	Turns the instrument input on or off.
	Up key, to select menu items during menu operation.
	Down key, to select menu items during menu operation.
	Left/Right key, to adjust the cursor to the specified location to set the value.

2.4 Fast function key

A combination of front board keys and Shift composition keys in IT8800 Series can realize functions marked at key bottom. For details, see table below.

 (Shift)+  (Short)	To start or end short circuit test.
 (Shift)+  (Tran)	To set dynamic operation parameters.
 (Shift)+  (List)	To set list operation function.
 (Shift)+  (Save)	To save existing setting load parameter values, e.g., voltage, current and power.
 (Shift)+  (Battery)	To operate battery test function.
 (Shift)+  (Prog)	To operate auto test function.
 (Shift)+  (Info)	To display model, version number and serial number of electronic load.
 (Shift)+  (System)	To set system menu.
 (Shift)+  (Config)	To configure system menu.
 (Shift)+  (Pause)	To pause operation during automatic test.
 (Shift)+  (Trigger)	Trigger key, to start up triggering functions.
 (Shift)+  (OCP)	To operate OCP test function.
 (Shift)+  (Setup)	To set specific parameters of constant voltage, constant current, constant resistance and constant power.
 (Shift)+  (OPP)	To operate OPP test function.
 (Shift)+  (Recall)	To select stored load parameter values, e.g., voltage, current and power setting values.
 (Shift)+  (Lock)	To operate Keyboard locking function.
 (Shift)+  (CZ)	Constant impedance mode (Incomplete support).

2.5 Function description of VFD status indicators

OFF	The load is off	Error	The load has error
CC	The load is under constant current mode	Trig	The load is waiting for triggering signal
CV	The load is under constant voltage mode	Sense	The load is under remote sense input mode
CR	The load is under constant resistance mode	Prot	The load is under software overcurrent protection status

CW	The load is under constant power mode	Rear	Start external analog quantity function
Rmt	The load is under remote operation mode	Auto	Start automatic voltage range
Addr	Send command under remote operation	*	Start keyboard locking function
SRQ	Serial request query	Shift	Shift key is pressed
LRV	LRV will be displayed on the screen when the load input reverses polarity.	-	-

2.6 Introduction of rear board

IT8800 Series rear board:

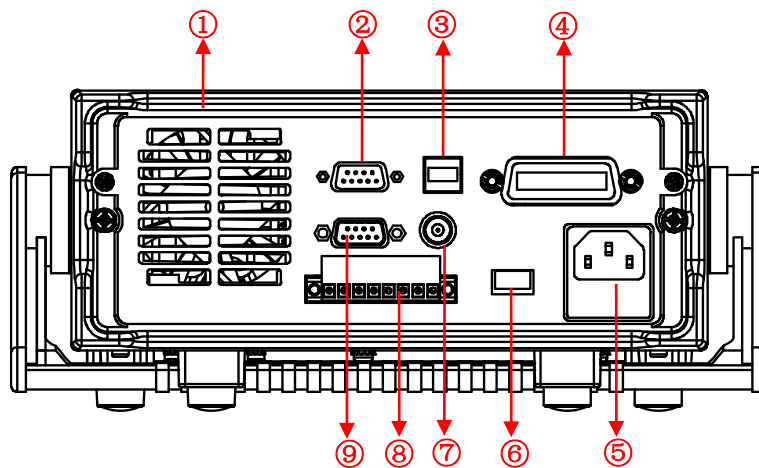

1. Cooling window
2. RS232 communication cable interface
3. USB communication cable interface
4. GPIB communication cable interface
5. AC power input socket (including fuse)
6. AC power switch key
7. Current monitoring terminal
8. Remote sense compensation terminal, external triggering terminal and external analog 0-10 V control terminal
9. External signal control interface

2.7 Power-on selftest

A successful selftest indicates that the purchased load product meets delivery standards and is available for normal usage.

Before operation, please confirm that you have fully understood the safety instructions.

WARNING

- To avoid burning out, be sure to confirm that power voltage matches with supply voltage.

- **Be sure to connect the main power socket to the power outlet of protective grounding. Do not use terminal board without protective grounding. Before operation, be sure that the electronic load is well grounded.**
 - **To avoid burning out, pay attention to marks of positive and negative polarities before wiring.**
-



Selftest steps

Normal selftest procedures:

1. Correctly connect the power line. Press **Power** key to start up.
The VFD screen of electronic load displays software version number "**BOIS Ver 1.10**".
2. After approximately 1s, the system is under selftest and the VFD display shows "**System Selftest....**"
3. After selftest, the VFD display information below.

0.0000V 0.0000A
0.00W CC=0.000A

Information description:

- The first line displays actual input voltage and current values.
 - The second line displays setting values of actual power value and current (voltage, power and resistance).
4. Press **[Shift] + [7]**(Info), the electronic load VFD screen displays related information of the product. Press   key to switch display of product model, product serial number and software version number.

Model:IT88XX
Ver:1.XX-1.XX
SN:XXXXXXXXXXXXXXXXXXXX

Exception handling

If the electronic load cannot start normally, please check and take measures by reference to steps below.

1. Check whether the power line is correctly connected and confirm whether the electronic load is powered.
Correct wiring of power line => 2
Incorrect wiring of power line => Re-connect the power line and check whether the exception is removed.
2. Check whether the power in On. **Power** key is under "I" On status.
Yes => 3
No => Please check the **Power** key to start power and check whether the exception is removed.
3. Check whether set power voltage of electronic load is larger than the power supply voltage. If set power voltage is 220 V and the supply voltage is 110 V, the electronic load cannot start.
4. Check whether the fuse of electronic fuse is burned out.
If yes, change fuse. Detailed steps:

- 1) Pull out power line and take out the fuse box at power line jack with a small screw driver. As shown below.

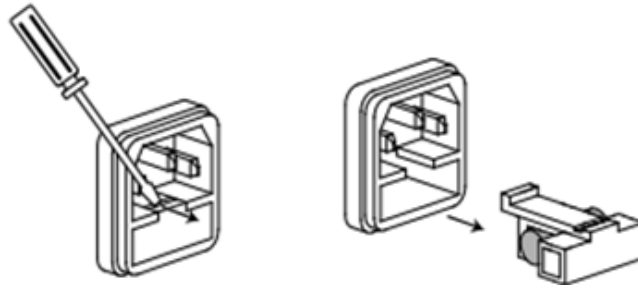

- 2) If the fuse is fused, please change fuse of same specification based on machine model. See the table below for matching information of fuse and machine model.

Product	Fuse specification(110VAC)	Fuse specification(220VAC)
IT8811	T 2.5A 250V	T1.25A 250V
IT8812	T 2.5A 250V	T1.25A 250V
IT8812B	T 2.5A 250V	T1.25A 250V
IT8812C	T 2.5A 250V	T1.25A 250V

- 3) After replacement, install the fuse box back to original position, as shown below.

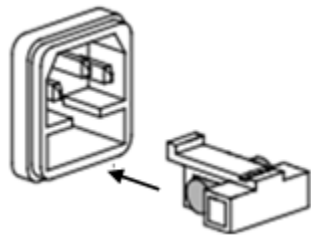

Chapter3 Function and Features

This Chapter will give a detailed description of functions and features of the electronic load. It is divided into the following parts:

- Switching of local/remote operation modes
- Constant-status operation mode
- Input control function
- Keyboard locking function
- Dynamic simulation function
- System menu function
- Configuration menu function
- Triggering function
- Dynamic test function
- OCP test function
- OPP test function
- Battery discharge test function
- CR-LED function
- Measurement of voltage rise time
- Save function
- VON function
- Protective function
- List function
- Terminal function of rear board
- To operate auto test function

3.1 Switching of local/remote operation modes

The electronic load is provided with local and remote operation modes. These two modes can be switched through communication commands. At initialization, the electronic load is defaulted under local operation mode.

- Local operation mode: for operating related functions through keys on the electronic load machine.
- Remote operation mode: for operating related functions of the electronic load on PC through a connection between the electronic load and PC. Under remote operation mode, except **[Local]** key, other keys on the board are disabled. The **[Local]** key can be used for switching to local operation mode.

3.2 Constant-status operation mode

The electronic mode can work under the 4 constant-state operation modes:

- Constant current operation mode (CC)
- Constant voltage operation mode (CV)
- Constant resistance operation mode (CR)
- Constant power operation mode (CW)

3.2.1 Constant current operation mode (CC)

Under CC mode, the electronic load will consume constant current in regardless of whether the input voltage changes or not, as shown in Fig. 3-1.

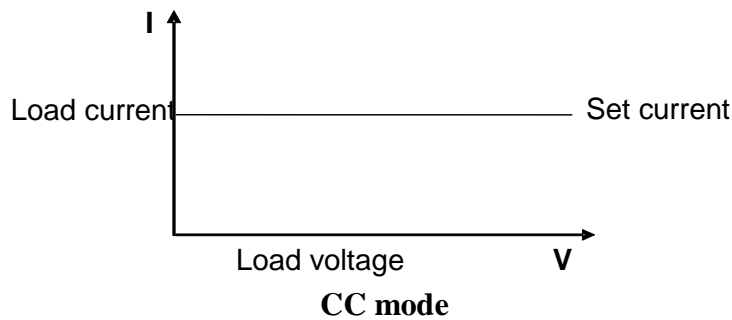





Fig. 3-1 Voltage-Current Relation Schema under CC Mode

Under CC mode, the electronic load provides three ways to set constant current.

- Rotate adjusting knob to set constant current value.
- Use numeric keys to input current value and press **[Enter]** key to confirm set constant current value.
- Use  moving cursor and press   to adjust values at corresponding positions.

Operation steps

1. Press **[CC]** key and **[Shift] + [CV]** to enter parameter setting screen.
Constant Current
Range=0.000A
2. Set maximum working current value and press **[Enter]** for confirmation.
Constant Current
Range =1.000A
3. Set maximum voltage value and press **[Enter]** key.
Constant Current
High=0.00V
4. Set minimum voltage value and press **[Enter]** key.
Constant Current
Low=0.000V
5. Set high and low rate and press **[Enter]** key.
Constant Current
High-Rate Low-Rate
6. Set ascending slope and press **[Enter]** key.
Constant Current
Rise up=0.000A/uS
7. Set descending slope and press **[Enter]** key.
Constant Current
Rise down=0.000A/uS
8. Complete parameter setting.
10.000V 0.0000A
0.00W CC=1.000A

NOTE

If the above method is for editing auto test step (as mentioned below), constant current range can also be set.

3.2.2 Constant voltage operation mode (CV)

Under CV mode, the electronic load will consume sufficient current to maintain the input voltage at setting voltage. As shown in Fig. 3-2.

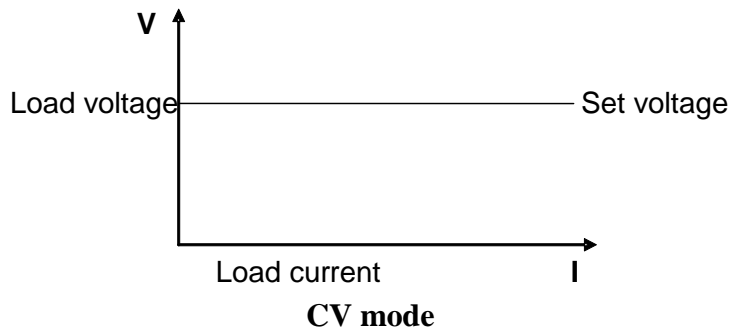



Fig. 3-2 Voltage-Current Relation Schema under CV Mode

Under CV mode, the electronic load provides three ways to modify constant voltage.

- Rotate adjusting knob to set constant voltage value.
- Use numeric keys to input voltage value and press **[Enter]** key to confirm set constant voltage value.
- Use  moving cursor and press  to adjust values at corresponding positions.

Operation steps

1. Press **[CV]** key and **[Shift] + [CV]** to enter parameter setting screen.
Constant Voltage
Range=120.00V
2. Set maximum working voltage value and press **[Enter]** for confirmation.
Constant Voltage
Range=2.33V
3. Set maximum current value and press **[Enter]** key.
Constant Voltage
High=66.000A
4. Set minimum current value and press **[Enter]** key.
Constant Voltage
Low=0.0000A
5. Complete parameter setting.
10.0000V 0.0000A
0.00W CV=2.33V

NOTE

If the above method is for editing auto test step (as mentioned below), constant voltage range can also be set.

3.2.3 Constant resistance operation mode (CR)

Under CR mode, the electronic load is equivalent to a constant resistance (as shown below) and will give linear change of current with input voltage change. As shown in Fig. 3-3.

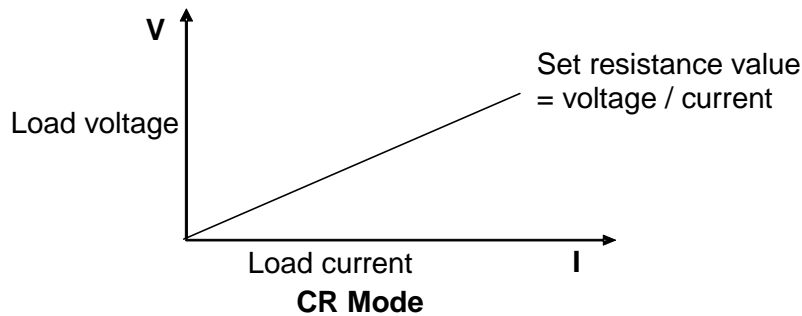



Fig. 3-3 Voltage-Current Relation Schema under CR Mode

Under CR mode, the electronic load provides three ways to modify constant resistance.

- Rotate adjusting knob to set constant resistance value.
- Use numeric keys to input resistance value and press **[Enter]** key to confirm set constant resistance value.
- Use  moving cursor and press  to adjust values at corresponding positions.

Operation steps

1. Press **[CR]** key and **[Shift] + [CV]** to enter parameter setting screen.
Constant Resistance
Range=7500.0Ω
2. Set maximum working resistance value and press **[Enter]** for confirmation.
Constant Resistance
Range=2000.0Ω
3. Set maximum voltage value and press **[Enter]** key.
Constant Resistance
High=130.0V
4. Set minimum voltage value and press **[Enter]** key.
Constant Resistance
Low=0.000V
5. Complete parameter setting.
10.0000V 0.0000A
0.00W CC=2.000Ω



NOTE

If the above method is for editing auto test step (as mentioned below), constant resistance range can also be set.

3.2.4 Constant power operation mode (CW)

Under CW mode, the electronic load will consume a constant power, as shown below. If input voltage rises, the input current decreases and power $P (= V * I)$ will maintain at setting power. As shown in Fig. 3-4.

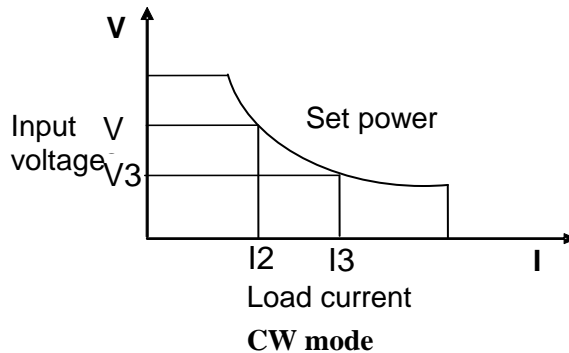



Fig. 3-4 Voltage-Current Relation Schema under CW Mode

Under CW mode, the electronic load provides three ways to modify constant power.

- Rotate adjusting knob to set constant power value.
- Use numeric keys to input power value and press **[Enter]** key to confirm set constant power value.
- Use  moving cursor and press  to adjust values at corresponding positions.

Operation steps

1. Press **[CW]** key and **[Shift] + [CV]** to enter parameter setting screen.
Constant Power
Range=400.00W
2. Set maximum working power value and press **[Enter]** for confirmation.
Constant Power
Range =300.00W
3. Set maximum voltage value and press **[Enter]** key.
Constant Power
High=130.00V
4. Set minimum voltage value and press **[Enter]** key.
Constant Power
Low=0.000V
5. Complete parameter setting.
10.0000V 0.0000A
0.00W CW=1.00W



NOTE

If the above method is for editing auto test step (as mentioned below), constant power range can also be set.

3.3 Input control function

Control input switch of the electronic load by pressing **[On/Off]** key on the front board. If **[On/Off]** lamp is on, the input is on; and if **[On/Off]** lamp is off, the VFD Off is On and the input is off. When the electronic load is on, the VFD working status indicator is off.

3.4 Keyboard locking function

Press the composite key **[Shift] + [On/Off]** to lock the instrument board key, and the VFD displays *. Under other function statuses, except **[On/Off]** key and **[Shift] + [7]** (Info), other keys are disabled. Press this composite key to cancel locking.

3.5 Short-circuit analog function

The load can analog a short circuited circuit at input terminal. Under board operation, press the **[Shift] + [1]** key to switch short circuit status. The short circuit status does not influence existing setting value. When the short circuit operation is switched back to OFF status, the load returns back to original setting status.

Actual current value consumed by load at short circuit depends on the existing working mode of load and current range. Under CC, CP and CR modes, maximum short-circuit current is 110% of current range. Under CV mode, short circuit current is equivalent to that constant voltage value of load is 0 V.

3.6 System menu function

Press **[Shift] + [8]** to enter system menu setting.

Initialize	INITIALIZE SYSTEM?	
	NO	Keep existing configurations
	YES	Recover all configurations to factory set values
Power-ON	POWER-ON PARAMENT	
	RST(default)	Set the input status of load at powering on as "status as delivered"
	SAV0	Set the input status of load at powering on as SAVE 0 value
Buzzer	BUZZER STATE	
	On(default)	Set the buzzer as ON status.
	Off	Set the buzzer as OFF status.
Knob	LOAD ON KNOB MODE	
	Update(default)	Real-time update
	Old	No update (Recover to original value at ON/OFF)
Trigger	TRIGGER SOURCE	
	Manual (Def)	Manual trigger
	External	External signal trigger mode
	Hold	Trig: IMM valid
	Bus	GPIB bus trigger mode
Displ	TIMER	
	On	Start function
	Off (default)	Stop function

Communication	COMMUNICATION		Select the interface for communication with a computer
	After interface entry, press the Arrow Key to select RS232 configuration	4800, 8, N non parity check, 1, NONE	
		9600 O even parity check CTS/RTS	
		19200 E odd parity check XON/XOFF	
		38400	
		57600	
	115200		
	USBTMC	Select the USB communication interface.	
	GPIB	Address (0-31)	
Protocol	PROTOCOL		Communication protocol selection
	SCPI (Default)	SCPI protocol	
	Extend-Table	Expand SCPI protocol for compatibility of other machines	

3.7 Configuration menu function

Press **[Shift] + [9]** to enter menu configuration (CONFIG MENU).

Von	VON LATCH		Start judgment voltage of load
	On	Start LATCH function	
	Point= 2V	Set load voltage	
	Off	Stop LATCH function	
	Point= 2V	Set load voltage	
Protect	PROTECT MENU		
	Max-P	Set hardware power protection	
	MAX POWER		
	Point=149.99W	Set hardware protective power value	
	A -Limit	Set software current protection	
	CURRENT LIMIT		
	On	Start function	
	Point=30A	Set software current protective value	
	Delay= 3S	Set software current protective delay	
	Off	Stop function	
	P- Limit	Set software power protection	
	POWER LIMIT		
	Point=150W	Set software power protective value	
	Delay= 3S	Set software power protective delay	
	Time	Set LOAD ON timer	
	ON-TIMER		
	On	Start function	
Delay=10S	Set LOAD ON timer value		
Off	Stop function		
Measure	MEASURE MENU		
	V-Range	Auto switch function of voltage range	
	VOLTAGE AUTO RANGE		
	On	Start auto voltage range	
	Off	Stop auto voltage range	
	TimeV1	Measure voltage rise/drop time	
	TIMER VOLTAGE1	Set starting voltage value	
Point=0.000V			

	TimeV2	Measure voltage rise/drop time
	TIMER VOLTAGE2	Set stopping voltage value
	Point=120.00V	
	FILTER	Smoothing function
	Average Count=2^(2~16)	Set of average count
CR-LED	CR LED MODE	Analog LED lamp function (under CR mode)
	On	Start CR-LED function
	Off	Stop CR-LED function
Remote-Sense	REMOTE SENSE STATE	Remote sense compensation measurement
	On	Start remote sense compensation function
	Off	Stop remote sense compensation function
Ext-Program	EXTNAL PROGRAM	External analog quantity function
	On	Start external 0-10 V analog quantity control function
	Off	Stop external 0-10 V analog quantity control function





3.8 Triggering function

Triggering function is necessary to operate dynamic pulse output and list output. There are five triggering methods to trigger the DUT.

Optional triggering sources of triggering function of electronic load comprise:

- **Key ([Trigger] key) trigger:** when key trigger is valid, press **[Shift] +**  key and the load will trigger an operation.
- **External trigger signal (TTL):** TRIG on the rear board is the triggering input terminal. When external trigger signal method is effective, after applying a low pulse (> 10 us), the load will trigger an operation.
- **Bus trigger:** when the bus trigger is valid, after the load receives a trigger command (GET or * TRG) from GPIB port, the load will trigger an operation.
- **Timing trigger:** when the timing trigger is valid, the load will automatically trigger an operation at intervals.
- **Trigger holding:** when trigger holding is valid, only when the load receives trigger command (TRIG:IMM), the load will trigger an operation.
- Select the triggering sources as follows:

Operation steps

1. Press **[Shift] + [8]** (system) to enter system menu setting screen.
Initialize Power-ON Buzzer
2. Press   to move to the Trigger and press **[Enter]** to enter triggering source selection screen.
SOURCE MANUAL
3. Press   to select trigger method and press **[Enter]** to complete setting.
Manual (Def): Manual trigger
External: external signal trigger
Hold: special command trigger
Bus: BUS command trigger
Timer: timer trigger
4. Press **[Esc]** to exit setting. The system displays original values under

different modes.

3.9 Dynamic test function

Through dynamic test operation, the electronic load can be switched between two setting parameters based on setting rules. This function can be used to test dynamic performances of power supply. For dynamic test operation, press **[Shift] + 2** key on the front board to enter the dynamic test menu. Before test, firstly, set parameters related to dynamic test operation, including dynamic test mode, A value, B value, pulse width time, frequency, duty ratio, etc. Under CC mode, current ascending and descending slopes should be set for dynamic test.



The dynamic test mode can be divided into continuous mode, pulse mode and toggle mode.

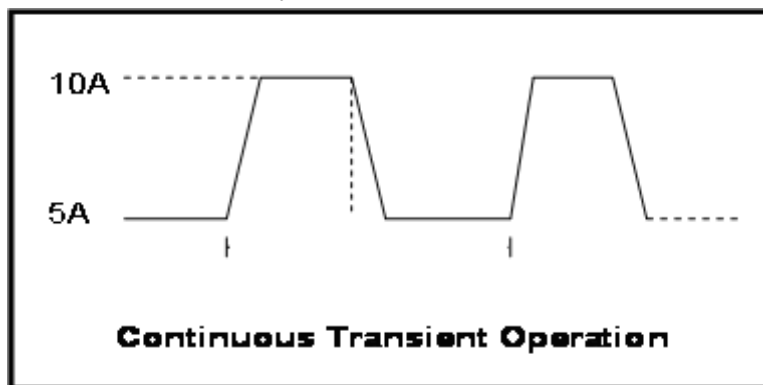

3.9.1 Continuous mode

Under continuous mode, after enabling dynamic test operation, the load will be switched continuously between A value and B value.



Taking CC mode as example (operations under other modes are similar), when output voltage and current of the tested instrument are 10 V and 3 A respectively, the load current will switch from 1 A and 2 A. Set the dynamic test parameters and perform the test as follows:

1. Press **[Shift] + [2]** keys.
TRANSITION
On Off
2. Operate  key and move to on. Press **[Enter]** key and select Continuous. Press **[Enter]** key (The Trig lamp that indicates VFD screen status is on)
TRANSITION
Continuous Pulse Toggle
3. Operate  key and select high rate and low rate. Move to the High-Rate and press **[Enter]** key.
TRANSITION
High-Rate Low-Rate
4. Set ascending slope and press **[Enter]** key.
TRANSITION
Rise up=30.000A/uS
5. Set descending slope and press **[Enter]** key.
TRANSITION

- Rise down=30.000A/uS
6. Set A value and press **[Enter]** key.
TRANSITION
Level A=1A
 7. Set B value and press **[Enter]** key.
TRANSITION
Level B=2A
 8. Set frequency value and press **[Enter]** key.
TRANSITION
Frequency=50Hz (0.01-25000Hz)
 9. Set duty ratio and press **[Enter]** key.
TRANSITION
Duty=98% (0.1%-99.9%)
 10. Start dynamic test and operate  key. Move to On and press **[Enter]** key.
TRANSITION
On Off
 11. Enter the dynamic test mode.
10.0000V 0.0000A
0.00W 0 TRAN
 12. Press **[On/Off]** key to open input and press **[Shift]** +  (Triggering key)
The load will continuously switch between A and B value. Time of operations is shown at bottom right.
 13. Press **[CC]/ [CV]/ [CR]/ [CW]** key or any composite function key to exit dynamic test function. Repeat Steps 1-12 to continue parameter setting and operation of dynamic test.



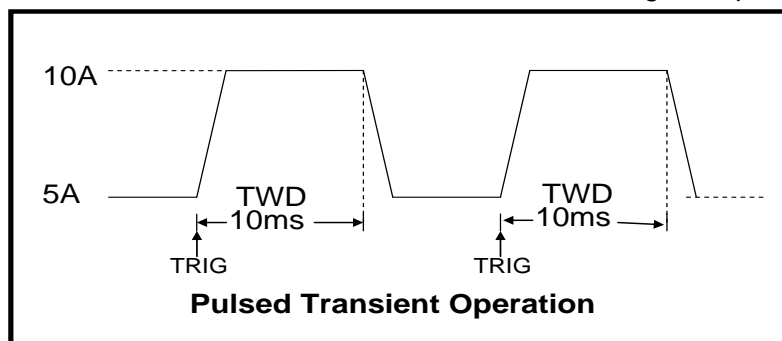

3.9.2 Pulse mode

Under pulse mode, after enabling dynamic test operation, the load will switch to A value after receiving of a trigger signal. Then the load will switch back to B value and be constant at B value after maintaining A for pulse width time.



Taking CC mode as example (operations under other modes are similar), when output voltage and current of the tested instrument are 10 V and 3 A respectively, the load current will switch from 1 A and 2 A. Set the dynamic test parameters and perform the test as follows:

1. Press **[Shift]** + **[2]** keys.
TRANSITION
On Off



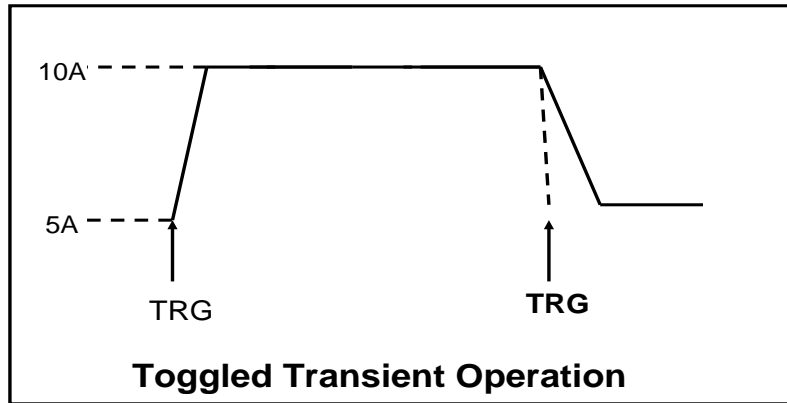

2. Operate  key and move to On. Press **[Enter]** key and select Pulse. Press **[Enter]** key (The Trig lamp that indicates VFD screen status is on)
TRANSITION
Continuous Pulse Toggle
3. Operate  key and select high rate and low rate. Move to the High-Rate and press **[Enter]** key.
TRANSITION
High-Rate Low-Rate
4. Set ascending slope and press **[Enter]** key.
TRANSITION
Rise up=30.000A/uS
5. Set descending slope and press **[Enter]** key.
TRANSITION
Rise down=30.000A/uS
6. Set A value and press **[Enter]** key.
TRANSITION
Level A=1A
7. Set B value and press **[Enter]** key.
TRANSITION
Level B=2A
8. Set time width and press **[Enter]** key.
TRANSITION
Pulse Width=5S (0.00002-3600S)
9. Start dynamic test and operate  key. Move to On and press **[Enter]** key.
TRANSITION
On Off
10. Enter the dynamic test mode.
10.0000V 0.0000A
0.00W 0 TRAN
11. Press **[On/Off]** key to open input and press **[Shift]** +  key (Triggering key)
The load will switch after receipt of every trigger signal. The load will continuously switch between A and B value. Time of operations is shown at bottom right.
12. Press **[CC]/ [CV]/ [CR]/ [CW]** key or any composite function key to exit dynamic test function. Repeat Steps 1-11 to continue parameter setting and operation of dynamic test.

3.9.3 Toggle mode

Under toggle mode, after enabling dynamic test operation, the load will be switched continuously between A value and B value after receipt of every trigger signal.



Taking CC mode as example (operations under other modes are similar), when output voltage and current of the tested instrument are 10 V and 3 A respectively, the load current will switch from 1 A and 2 A. Set the dynamic test parameters and perform the test as follows:

1. Press **[Shift] + [2]** keys.
TRANSITION
On Off
2. Operate  key and move it to on. Press **[Enter]** key and move the cursor to Toggle. And press **[Enter]** key (The Trig lamp that indicates VFD screen status is on)
TRANSITION
Continuous Pulse Toggle
3. Operate  key and select high rate and low rate. Move to the High-Rate and press **[Enter]** key.
TRANSITION
High-Rate Low-Rate
4. Set ascending slope and press **[Enter]** key.
TRANSITION
Rise up=30.000A/uS
5. Set descending slope and press **[Enter]** key.
TRANSITION
Rise down=30.000A/uS
6. Set A value and press **[Enter]** key.
TRANSITION
Level A=1A
7. Set B value and press **[Enter]** key.
TRANSITION
Level B=2A
8. Start dynamic test and operate  key. Move to On and press **[Enter]** key.
TRANSITION
On Off
9. Enter the dynamic test mode.
10.0000V 0.0000A
0.00W 0 TRAN
10. Press **[On/Off]** key to open input and press **[Shift] +**  key (Triggering

key)

The load will switch after receipt of every trigger signal. The load will switch between A and B value for one time. Time of operations is shown at bottom right.

- Press **[CC]/ [CV]/ [CR]/ [CW]** key or any composite function key to exit dynamic test function. Repeat Steps 1-10 to continue parameter setting and operation of dynamic test.

3.10 OCP test function

The IT8800 series electronic load is provided with overcurrent protection test function (OCP). Under OCP test mode, when input voltage reached Von value, delay for a while for the electronic load to latch. Ascend value by step value at regular interval. At the same time, check the load input voltage and judge whether it is higher than standard voltage value. If higher, it indicates that OCP does not occur. Repeat current stepping operation till the load operates to the cutoff current; if lower, it indicates that OCP does occur. Check whether the existing current value is within target scope again. If yes, PASS the test.

Press **[Shift] + [CC]** (OCP) keys to enter OCP test function setting screen.

OCP TEST	Run	OCP TEST	
			Operate OCP test documents
	Recall	OCP TEST	
		Recall OCP File=1	Recall OCP test documents (1-5)
	Edit	OCP TEST	
		1:Voltage on level=0.000V	Set Von voltage value
		2:Voltage on Delay=0.00S	Set Von voltage delay time
		3:Current Range=0.000A	Set working current range
		4:Start Current=0.000A	Set initial current value
		5:Step Current=0.000A	Set step current value
		6:Step Delay=0.00S	Set step delay time
		7:End Current=0.000A	Set cutoff current value
		8:OCP Voltage=0.000V	Set OCP value
		9:Max Trip Current=0.000A	Set overcurrent range (maximum value)
	10:Min Trip Current=0.000A	Set overcurrent range (minimum value)	
	Save OCP File=1 (1-5)	Save OCP test documents	

Operating steps:

- Press **[Shift] + ** key to start OCP test. If within range, PASS the test and the board will display as follows:

9.9973V	0.0005A		
0.01W	5.100A	PASS	STOP

If not, there is FAULT and the board will display as follows:

9.9973V	0.0005A		
0.01W	5.100A	FAULT	STOP

- End test. Press **[ESC]** to return to setting screen. Press **[ESC]** again to exit.



NOTE

If the set OCP voltage value is higher than the power voltage value, the OCP will fail to operate and the board will display as follows:

9.9990V	0.0009A		
0.01W	0.100A	FAULT	STOP

3.11 OPP test function

The IT8800 series electronic load is provided with overpower protection test function (OPP). Under OPP test mode, when input voltage reached Von value, delay for a while for the electronic load to latch. Ascend value by step value at regular interval. At the same time, check the load input voltage and judge whether it is higher than standard voltage value. If higher, it indicates that OPP does not occur. Repeat power stepping operation till the load operates to the cutoff power; if lower, it indicates that OPP does occur. Check whether the existing power value is within target scope again. If yes, PASS the test.

Press **[Shift] + [CW]** keys to enter OPP test function setting screen:

OPP TEST	Run	OPP TEST	
			Operate OPP test documents
	Recall	OPP TEST	
		Recall OPP File=1	Recall OPP test documents (1-5)
	Edit	OPP TEST	
		1:Voltage on level=0.000V	Set Von voltage value
		2:Voltage on Delay=0.00S	Set Von voltage delay time
		3:Current Range=0.000A	Set current range
		4:Start Power=0.000W	Set initial power value
		5:Step Power=0.000W	Set step power value
		6:Step Delay=0.00S	Set step delay time
		7:End Power=0.000W	Set cutoff power value
		8:OCP Voltage=0.000V	Set OCP value
		9:Max Trip Power =0.000W	Set overpower range (maximum value)
	10:Min Trip Power =0.000W	Set overpower range (minimum value)	
	Save OPP File=1 (1-5)	Save OPP test documents	

Operating steps:

1. Press **[Shift] +**  key to start OPP test. If within range, PASS the test and the board will display as follows:

9.996V	0.0007A		
0.01W	49.10W	PASS	STOP

If not, there is FAULT and the board will display as follows:

9.996V	0.0007A		
0.01W	48.6W	FAULT	STOP

2. End test. Press **[ESC]** to return to setting screen. Press **[ESC]** again to exit.



NOTE

If the set OPP voltage value is higher than the power voltage value, the OPP will fail to operate and the board will display as follows:

9.996V	0.0007A		
0.01W	0.1W	FAULT	STOP

3.12 Battery discharge test function

In the IT8800 series electronic load, constant current mode is applied for discharge test with programmatic setting of stop voltage/capacity/discharging time. If stop voltage is set as the stop condition, the system determines whether the battery is about to reach the set threshold value or unsafe status when the battery voltage is low, and if yes, an automatic stop will be activated. During test, the operator can observe voltage, discharging time and discharged capacity of battery. Battery discharge test is a necessary step before battery replacement for it can reflect reliability and remaining life of battery.

Press **[Shift] + [5]** keys to enter function testing screen of battery discharge test.

STOP CONDITION	Voltage	STOP Condition	
		Stop Voltage=0.000V	Set stop voltage
	Capability	STOP Condition	
		Stop Capability=0.000Ah	Set battery stop capacity
	Timer	STOP Condition	
		Stop Timer=0S	Set discharge time

Operation method:

1. Press **[On/Off]** key to cut off load input status. Connect the battery to be tested. Under CC mode, press **[Shift] + [5]** keys to enter battery discharge function menu and select one of the three methods for test based on actual requirements.
2. Set discharge stopping conditions:
 - Type I: Press **[Shift] + [5]** keys and select Capability. Press **[Enter]** key and the VFD displays Stop Capability =Ah(0~999.999Ah). Set battery stop capacity. Press **[Enter]** key. When set battery capacity is reached, the load input status will automatically be OFF.
 - Type II: Press **[Shift] + [5]** keys and select Voltage. Press **[Enter]** key and the VFD displays Stop Voltage=V. Set stop voltage and press **[Enter]** key to start discharge test. When the battery voltage drops to stop voltage, the load input status will automatically be OFF.
 - Type III: Press **[Shift] + [5]** key and select Timer. Press **[Enter]** key and the VFD displays Stop Timer=S (0~99999S). Set discharge time. When the set stop time is reached, the load input status will automatically be OFF.
3. Press **[Shift] + [Enter]** key to start test. The board will display discharge voltage, current discharge time and discharged capacity (AH).
4. Press **[ESC]** key to exit battery capacity test mode in any three methods.

3.13 CR-LED test function

With adding of diode break-over voltage setting in the IT8800 series electronic load under conventional CR mode, the electronic load only works when voltage applied at its both ends is higher than the diode break-over voltage to give a real simulation of diode working principle, i.e., the ripple current at real LED test.

Detailed steps of LED power test:

1. Start CR-LED function

Press **[Shift] + [9]** keys to enter configuration menu. Press Right Key and select "CR-LED". Press **[Enter]** key for entry. Select "on" and press **[Enter]** key. Press **[ESC]** key to exit.

2. Set CR mode and resistance value

Press **[CR]** key and set corresponding constant resistance (as R calculated below).

3. Set Vd value

Press **[Shift] + [CV]** keys for a series of related setting: range=7500.0, high=130V, low=0V, which may remain the original values. Vd will be set based on the calculation below.

Calculation method of Vd and R:

$$V_d = V * 0.8 \quad R = 0.2V/I$$

Where:



- V: constant working voltage of load LED of LED constant current source;
- I: output current of LED constant current source;
- Vd: break-over voltage of diode (string);
- R: constant resistance;

3.14 Measurement of voltage rise time

The IT8800 series electronic load is provided with special voltage rise/drop time measurement function. This function gives a simple analog of voltage rise/drop speed of oscilloscope test power.

Operation methods:

Set initial voltage and final voltage

1. Press **[Shift] + [9]** keys to enter configuration menu. Press Right key. Select "Measure" and press **[Enter]** key.
2. Press  to select "TimeV1". Press **[Enter]** key. Press numeric keys to set initial voltage value and press **[Enter]** key.
3. Press  to select "TimeV2". Press **[Enter]** key. Press numeric keys to set final voltage value and press **[Enter]** key.
4. Press **[ESC]** to exit setting.

Start timer function

5. Press **[Shift] + [8]** keys to enter system menu. Press Right key till "Displ" flicks and press **[Enter]** key.
6. Press  key to select "On". Start timer function and press **[Enter]** key.
7. Press **[ESC]** to exit setting.
8. VFD second line will display time 0.0000S between power value and set value.

OFF CC		
0.0001V		0.0002A
0.00W	0.0000S	CC=0.000A

Measurement of rise time

9. Connect DC power to be tested to the input terminal of the electronic load. The power is set with a value that is higher than the set final voltage value. Keep power output in OFF status.
10. Set a constant current value on the load and open the load input.
11. Open power output.
12. The electronic load timer starts timing. After ending, time will keep stable, which is rise time of voltage.
13. Close the power output. The electronic load VFD will display voltage drop time.

3.15 Configuration save function

The electronic load can save some commonly-used parameters in 100-group NVM for convenient and fast usage. Saving parameters comprise working mode, voltage, current, etc. The **[Shift] + [4]** (Save) keys can be used for saving parameters. The **[Shift] + [Enter]** (Recall) key is for quick invoking.

Operation steps

If the operator needs to save configured parameter values for direct recall in follow-up operation, refer to the steps below:

E.g., power supply 6V and 3A. The electronic load works under constant current (CC) 1A. Save "CC 1A" in register 9 for recall.

● SAVE

1. Set parameters and press **[Shift] + [4]** keys to save data. Press **[9]** key (to select in which group the data is to be saved).

```
5.8949V  0.99994A
5.89W    SAVE 9
```

2. Press **[Enter]** key.

```
5.8949V  0.99994A
5.89W    cc=1.000A
```

● RECALL

1. Press **[Shift] + [Enter]** (Recall) key and press **[9]** (to select from which group the data is recalled).

```
5.8949V  0.99994A
5.89W    cc=1.000A
```

3.16 VON function

When testing some power products with slow voltage rise speed, if the electronic load input is opened before power, the power may latch protection. In this way, the user may set VON value. The electronic load only latches when power voltage is higher than this value.

Press **[Shift] + [9]** keys to enter configuration menu. Set voltage value in Voltage on under configuration menu to control on/off status of electronic load. When VON LATCH function is started, it indicates that Von Point latches load

status.



NOTE

Please confirm whether it is necessary to set loading voltage, a step that provides convenience for limiting working voltage value. If not necessary, do not set the loading voltage without authorization to prevent unnecessary trouble from failure of loading.

If the instrument cannot load, please firstly check whether the VON function is set. If yes, reset the Von value to minimum value (which may be directly set as 0. If minimum voltage value of instrument is not 0, press 0 for confirmation and the menu will automatically set the value as minimum value).

This function is invalid under CV mode.

When VON LATCH function is started, the load starts load test only when the power voltage rises and is higher than Von Point loading voltage. When the power voltage drops and is lower than Von Point unloading voltage, the load will not unload.

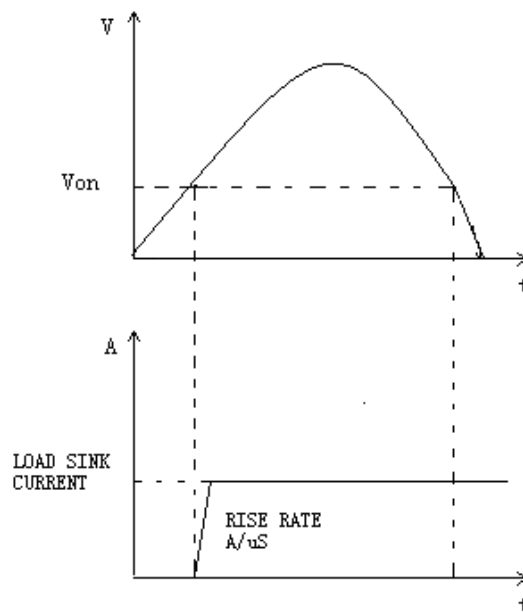

Load working range when VON LATCH is started

3.17 Protective function

The load is provided with following protective functions: overvoltage protection (OVP), overcurrent protection (OCP), overpower protection (OPP) and overtemperature protection (OTP).

If any one of the above protections is enabled, the load will have corresponding actions. Press any key on the front board to reset protection functions. For example, in case of overtemperature protection, the load will give alarm and the input will automatically switch to OFF status. The load VFD will display OTP.

3.17.1 Overvoltage protection (OVP)

The load will be immediately OFF and the buzzer will sound if the overvoltage circuit is triggered. OV and VF bits of the status register will be set and OVP will be displayed on the screen of the load till resetting. In case of overvoltage protection, the VF pin of the 8-pin connector on rear board of the load outputs TTL high level and the VF pin can be used for controlling output status of the power to be tested.

Clear overvoltage protection status

Inspect whether voltage of object under test is within load rated voltage or set protection voltage range. If not, disconnect the object. Press any key on load front board (or send command to PROTection:CLEAr), the load front board (OVP) word will get cleared and the load will exit OVP protection status.

3.17.2 Overcurrent protection (OCP)

The electronic load is provided with two kinds of overcurrent protections: hardware overcurrent protection and software overcurrent protection.

- Hardware overcurrent protection: maximum load current of the electronic load is limited within about 110% of the existing current range by hardware. When the hardware triggers overcurrent protection, OC bit of the status register will be set; when such protection is removed, the OC bit will be reset. The On/Off status of load will not be changed by the hardware overcurrent protection.
- Software overcurrent protection: the user can set load software overcurrent protection value following steps: press **[Shift] + [9]** key >Protect> A-limit (set as ON). I point is set as OCP current value and A delay set as pre-alarm delay time. When software overcurrent protection function is on, if the loading current value exceeds delay of such overcurrent protection set value, the load will automatically be OFF and the VFD will display OCP. At the same time, OC and PS bits of the status register will be set and keep till reset.

Clear overcurrent protection status

Inspect whether current of object under test is within load rated current or set protection current range. If not, disconnect the object. Press any key on load front board (or send command to PROTection:CLEAr), the load front board (OCP) word will get cleared and the load will exit OCP protection status.

3.17.3 Overpower protection (OPP)

The electronic load is provided with two kinds of overpower protections: hardware overpower protection and software overpower protection.

- Hardware overpower protection: the user can set load hardware overpower protection. Load overpower will be limited to existing power value. The On/Off status of load will not be changed by the hardware overpower protection.
- Software overpower protection: the user can set load software overpower protection value following steps: press **[Shift] + [9]** key >Protect> Point set OPP power value. P limit is set as pre-alarm delay time. If the loading power value exceeds delay of such overpower protection set value, the load will automatically be OFF and the VFD will display OPP. At the same time, OP and PS bits of the status register will be set and keep till reset.

Clear overpower protection status

Inspect whether power of object under test is within load rated power or set protection power range. If not, disconnect the object. Press any key on load front board (or send command to PROTection:CLEAr), the load front board (OPP) word will get cleared and the load will exit OPP protection status.

3.17.4 Overtemperature protection (OTP)

When internal power device of load is higher than about 85 °C, the load is under temperature protection. At this time, the load will automatically be OFF and VFD will display OTP. At the same time, OT and PS bits of the status register will be set and keep till reset.

Clear overtemperature protection

When load temperature is decreased to protection point, press any key on load front board (or send command to PROTECTION:CLEAr), the load front board (OTP) word will get cleared and the load will exit OTP protection status.

3.18 List operation

LIST mode provides an accurate, fast and low-cost way to complete any complicated current change mode, which enables synchronization of internal or external signals in multiple quasi-bit load precision tests.

When different trigger sources are selected, the LIST function will form a variety of complex sequences by editing step value, pulse width and slope of each step to meet complicated test requirements. LIST parameters comprise designation of input list file, input step count (2-84 steps at maximum), step time (0.00002s – 3600s) as well as setting value and slope of each step. The list file can be stored in non-volatile RAM available for a quick output in case of usage. The user can edit 7 groups of list files at maximum.

If the load operation mode is at List operation, the load will start List operation when it receives a trigger signal till completion or receipt of another trigger signal.

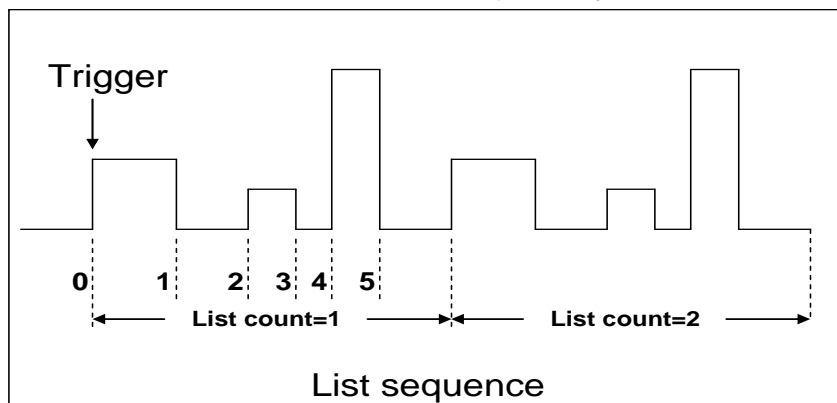

Before List operation, be sure to edit List operation files and save them in load non-volatile RAM. Refer to examples below to know how to execute List operation through board. It is assumed that output voltage and current of the tested instrument are 10V and 3A respectively and the load is under CC mode.



Edit the LIST file and trigger to operate this file. Operation steps:



Operation steps

1. Press **[Shift] + [3]** key. Operate Left/Right key. Move to Edit and press **[Enter]** key.
LIST
On Recall Edit
2. Operate Left/Right key and move to the High-Rate and press **[Enter]** key.
EDIT LIST
High-Rate Low-Rate
3. Set CC range and press **[Enter]** key.
EDIT LIST
Current Range=3A
4. Edit number of steps. Press **[2]** key to edit two steps. Press **[Enter]** key.
EDIT LIST
File Step=2 (2-84)

5. Edit current value in step 1 and press **[Enter]** key.
EDIT LIST
Step 001 Level=1A
6. Edit slope in step 1 and press **[Enter]** key.
EDIT LIST
Step 001 Rate=0.1A/uS
7. Edit time in step 1 and press **[Enter]** key.
EDIT LIST
Step 001 Width=5S
8. Edit current value in step 2 and press **[Enter]** key.
EDIT LIST
Step 002 Level=2A
9. Edit slope in step 2 and press **[Enter]** key.
EDIT LIST
Step 002 Rate=0.1A/uS
10. Edit time in step 2 and press **[Enter]** key.
EDIT LIST
Step 002 Width=5S
11. Edit repeat count and press **[Enter]** key.
EDIT LIST
Repeat Count=3
12. Save all edited files and press **[Enter]** key.
EDIT LIST
Save List File=1 (1-7)
13. Operate  key and move to On. Press **[Enter]** key (The Trig lamp that indicates VFD screen status is on). Press **[ESC]** key to exit setting.
LIST
On Recall Edit
14. Press **[On/Off]** key to open input and press **[Shift]** +  key (Triggering key).
List operation running
15. Press **[CC]/ [CV]/ [CR]/ [CW]** key or any composite function key to exit List test function.

For direct recall of existing List files and triggering of List operation, refer to steps below:

Operation steps

1. Press **[Shift]** + **[3]** keys and ensure that ON lamp flicks. If not, press **[Enter]** before operation. Press  key to select Recall. And press **[Enter]** for confirmation.
LIST
On Recall Edit
2. Select edited files and press **[Enter]** for confirmation.
Recall List File=1
3. Operate  key and move to On. Press **[Enter]** key (The Trig lamp

that indicates VFD screen status is on). Press **[ESC]** key to exit setting.

LIST

On Recall Edit

4. Press **[On/Off]** key to open input and press **[Shift] +**  key (Triggering key)

List operation.

3.19 Terminal function of rear board

Terminals on IT8800 rear board comprise remote sensor terminal, external trigger terminal, external analog control terminal, voltage fault indication terminal, external On/Off control terminal and current monitoring terminal. Terminal schematic (as shown below):

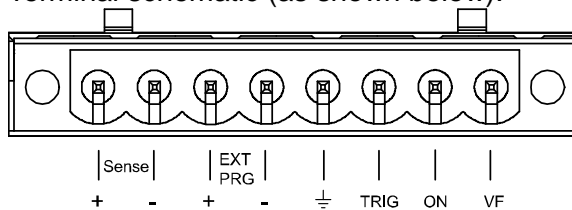

Pin	Pin function
Sense+, Sense-	Remote sense terminal
EXT PRG+, EXT PRG-	External analog control terminal
⏚	Negative input terminal for TRIG, ON and VF
TRIG	Positive input terminal for trigger
ON	Positive input terminal for external On/Off control
VF	Positive input terminal for voltage fault indication

3.19.1 Remote sense compensation functions

Under CC, CV, CR or CP mode, if the load consumes large current, a large voltage drop will be detected in connection line between tested instrument and load terminal. To ensure measurement accuracy, a remote sense measurement terminal is provided at load rear board to compensate voltage drop lost in wire.

Remote sense operation: SENSE (+) and SENSE (-) are remote input terminals. To avoid voltage drop caused by long input wire of load, the remote sense test allows direct measurement at input terminal source so as to improve measurement accuracy.

Operation steps of remote sense measurement:

1. Press **[Shift] + [9]** keys to enter menu. Operate  key and select Remote-Sense. Press **[Enter]** key.
2. Select ON and start Sense function. Set load in remote sense measurement mode.
3. Remote sense measurement is connected. Refer to figure below for detailed wiring.

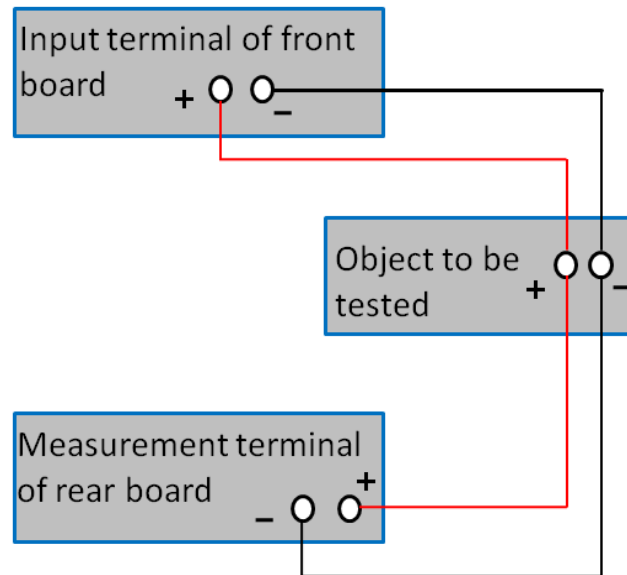

3.19.2 External trigger function

When rear board triggering mode is selected, firstly, set the trigger source as External and the triggering signal is input from the rear board TRIG terminal.

Press **[Shift] + [8]** keys to enter system menu. Click Right key till Trigger appears and flicks. Press **[Enter]** to entry and press  to select External. Press **[Enter]** for confirmation. Press **[ESC]** to exit the menu.

When external trigger is selected, the positive and negative TRIG terminals will generate trigger signal and the low pulse is valid.

Input corresponding to one trigger can be used for triggering dynamic test, LIST test and auto test.

3.19.3 External analog quantity test

Loading voltage or current of the electronic load can be controlled by EXT PRG (positive and negative) analog quantity terminals on rear board. Connect 0-10V adjustable voltage at the EXT PRG terminal to analog input from 0- full range so as to adjust input voltage and current of load (10V corresponds to voltage or current of load at full range).

3.19.4 Voltage fault indication

When load is under overvoltage protection or terminal reverse polarity protection, VF pin voltage fault indication terminal outputs high level.

3.19.5 External On/Off Control

The load input switches can be controlled by the external TTL electrical level. During external input control, the **[On/Off]** key will become invalid and the load input switches can only be controlled by the external TTL electrical level. The load input will be switched on in case of low level external input; and the load input will be switched off in case of high level external input.

3.19.6 Current monitoring (I Monitor)

The 0-10V analog quantity output signal of current monitoring output terminal represents input current to which the terminal belongs from 0 to full range. An external voltmeter or oscilloscope can be connected to display input current change.

3.20 External Signal Control Interface

Besides the RS232 communication interface, the rear panel is also equipped with a DB-9 COM interface, which is the external signal control interface used in auto test. The pin definitions are as follows.

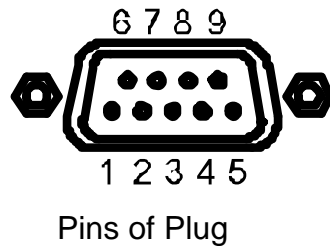

Base pin number	Description
1	The auto test runs last step.
2	The auto test starts to run.
3	During the auto test, the input is turned on.
4	Output the failure signal of the auto test.
5	GND
6	The auto test runs next step.
7	The auto test pauses.
8	The auto test outputs via signal.
9	The warning tone signal of auto test outputs.

You can control the auto test process and test results by transmitting input/output signals through external signal control interface. Different pins of the interface control different functions. Detailed instructions are listed on the above table.

Under external analog quantity control mode, you can switch CC mode through pin 1 of the interface and switch CV mode through pin 6.

3.21 Auto test function

The IT8800 series electronic load delivers strong auto test functions, which can analog several tests. A total of 10 groups of test files can be edited, and each group test file has 10 steps. Therefore, a maximum of 100 steps can be edited and saved in EEPROM.



NOTE

In the following editing procedures, "Y" indicates selected status. To cancel selected status, press numeric key of corresponding step again.

Edit test files following steps below:

Operation steps

- Press **[Shift] + [6]** keys.
PROGRAM
Run Recall Edit
- Operate  key and move to Edit. Press **[Enter]** key to enter editing test files.
EDIT PROGRAM
Active Sequence=0987654321
- Press numeric key to select test step and press **[Enter]** key. Active Sequence= 09876543YY (indicating that 1/2 step has been selected).
EDIT PROGRAM
Active Sequence=09876543YY
- Select whether pause is necessary for these two steps. If step 2 is to be

paused, press **[2]** key. If not, directly press **[Enter]** key.

EDIT PROGRAM

Pause Sequence=□□□□□□□Y1

5. Select whether short-circuit test is necessary for these two steps. If step 1 is to be tested, press **[1]** key. If not, directly press **[Enter]** key.

EDIT PROGRAM

Short Sequence=□□□□□□□2Y

6. Set loading time of step 1. If 2S is required, directly press **[2]** key on the board. Press **[Enter]** key.

EDIT PROGRAM

SEQ01 On Time=2S

7. Set unloading time of step 1. If 2S is required, directly press **[2]** key. Press **[Enter]** key.

EDIT PROGRAM

SEQ01 Off Time=2S

8. Set test delay time of step 1. If 1S is required, directly press **[1]** key. Press **[Enter]** key. T_{pf} is delay time before measurement.

EDIT PROGRAM

SEQ01 P/F Delay Time=1S

9. Set loading time of step 2. If 2S is required, directly press **[2]** key. Press **[Enter]** key.

EDIT PROGRAM

SEQ02 On Time=2S

10. Set unloading time of step 2. If 2S is required, directly press **[2]** key. Press **[Enter]** key.

EDIT PROGRAM

SEQ02 Off Time=2S

11. Set test delay time of step 2. If 1S is required, directly press **[1]** key. Press **[Enter]** key. T_{pf} is delay time before measurement.

EDIT PROGRAM

SEQ02 P/F Delay Time=1S

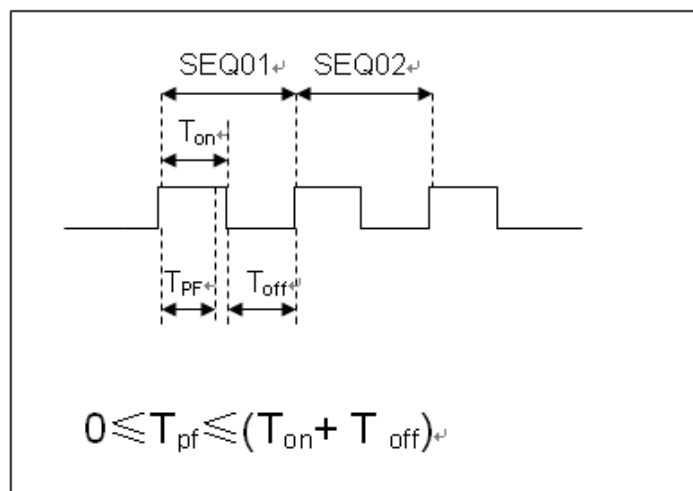

T_{pf} is delay time before measurement.

12. Set conditions for stop test. COMPLETE means to stop after all tests are completed and FAILURE means to stop in case of test error. Press **[Enter]** key.

PROGRAM

Complete-Stop Failure-Stop

13. Determine whether to link to next group of test file. If it is to link to second group, press **[2]** key. 0 means not to link to other test files. Press **[Enter]** key.

PROGRAM

Chain Program File=0 (0-10)

Correspondence Table of Auto test files and step parameter saving.

Program 1 Sequence	1	2	3	4	5	6	7	8	9	10
Save Group	1	2	3	4	5	6	7	8	9	10
Program 2 Sequence	1	2	3	4	5	6	7	8	9	10
Save Group	11	12	13	14	15	16	17	18	19	20
:										
:										
Program 10 Sequence	1	2	3	4	5	6	7	8	9	10
Save Group	91	92	93	94	95	96	97	98	99	100

14. Save the programmed files in EEPROM. A total of 10 groups of files can be saved. If it is to save edited files in group 1, press **[1]** key. Press **[Enter]** key.

PROGRAM

Save Program File=1 (1-10)

15. Press **[ESC]** key to exit editing menu.

The above steps only set entire framework of auto tests. Additional setting is required for specific parameters in each step. This design will facilitate modification of parameters in a single step.

16. Select desired working mode and set working parameters. Press **[Shift] + [CV]** to enter parameter setting.

10.0000V 0.0000A

0.00W CC=1.000A

17. It is assumed that step 1 edits CC mode as follows: current: 2A, maximum voltage value: 10V, and minimum voltage value: 2V; and step 2 edits CV mode as follows: voltage: 3V, maximum current value: 5A, and minimum current value: 0A. After parameter setting in each step, press **[ESC]** to exit setting menu. Press **[Shift] + [4]** key for saving. **Settings at each step should be independently saved. Refer to the Correspondence Table for saving position.**
18. It is necessary to recall test files for running after editing auto test files.

Recall test file for running

To recall edited test files from EEPROM quickly after re-energizing instrument, refer to the method below.

1. Press **[Shift] + [6]** keys.



PROGRAM

Run Recall Edit

2. Operate  key, select Recall and press **[Enter]** key.

RECALL PROGRAM

Recall Program File=1

3. Operate  key, select Run and press **[Enter]** key.
PROGRAM
Run Recall Edit
4. Display auto test file 1.
PRG01 STOP
5. Press **[Shift]** +  key.
Operate auto test file 1. Press **[Shift]** + **[0]** key to pause auto test. Press
 key for next step.

Chapter4 Technical Specification

4.1 Specification

Model		IT8811		IT8812	
Rated value (0~40 °C)	Voltage	0~120V		0~120V	
	Current	0~3A	0~30A	0~3A	0~30A
	power	150 W		250W	
	Min-op-V	0.11V at 3A	1.1V at 30A	0.11V at 3A	1.1V at 30A
CV mode	range	0.1~18V	0.1~120V	0.1~18V	0.1~120V
	resolution	1mV	10mV	1mV	10mV
	accuracy	$\pm(0.05\%+0.02\%FS)$	$\pm(0.05\%+0.025\%FS)$	$\pm(0.05\%+0.02\%FS)$	$\pm(0.05\%+0.025\%FS)$
CC mode	range	0~3A	0~30A	0~3A	0~30A
	resolution	0.1mA	1mA	0.1mA	1mA
	accuracy	$\pm(0.05\%+0.05\%FS)$	$\pm(0.05\%+0.05\%FS)$	$\pm(0.05\%+0.05\%FS)$	$\pm(0.05\%+0.05\%FS)$
CR mode	range	0.05Ω~10Ω	10Ω~7.5KΩ	0.05Ω~10Ω	10Ω~7.5KΩ
	resolution	16bit		16bit	
	accuracy	0.01%+0.08S	0.01%+0.0008S	0.01%+0.08S	0.01%+0.0008S
CP mode	range	150W		250W	
	resolution	10mW		10mW	
	accuracy	0.1%+0.1%FS		0.1%+0.1%FS	
Dynamic mode					
Dynamic mode	CC mode		CC mode		
	T1 & T2	20uS~3600S /Res:1 uS		20uS~3600S /Res:1 uS	
	accuracy	5uS±100ppm		5uS±100ppm	
	slew rate	0.0001~0.25A/uS	0.001~2.5A/uS	0.0001~0.25A/uS	0.001~2.5A/uS
Measurement range					
Readback voltage	range	0~18V	0~120V	0~18V	0~120V
	resolution	0.1 mV	1 mV	0.1 mV	1 mV
	accuracy	$\pm(0.025\%+0.025\%FS)$	$\pm(0.025\%+0.025\%FS)$	$\pm(0.025\%+0.025\%FS)$	$\pm(0.025\%+0.025\%FS)$
Readback current	range	0~3A	0~30A	0~3A	0~30A
	resolution	0.01mA	0.1mA	0.01mA	0.1mA
	accuracy	$\pm(0.05\%+0.05\%FS)$		$\pm(0.05\%+0.05\%FS)$	
Readback power*2	range	150W		250W	
	resolution	10mW		10mW	
	accuracy	$\pm(0.1\%+0.1\%FS)$		$\pm(0.1\%+0.1\%FS)$	
Protection range					
OPP	$\cong 150W$			$\cong 250W$	
OCP	$\cong 3.3A$	$\cong 33A$	$\cong 3.3A$	$\cong 33A$	
OVP	$\cong 120V$			$\cong 120V$	
OTP	$\cong 85^{\circ}C$			$\cong 85^{\circ}C$	
specification					
Short circuit	current	$\cong 3.3/3A$	$\cong 33/30A$	$\cong 3.3/3A$	$\cong 33/30A$
	voltage	0V	0V	0V	0V
	resistance	$\cong 35m\Omega$	$\cong 35m\Omega$	$\cong 35m\Omega$	$\cong 35m\Omega$
Input impedance	150KΩ			150KΩ	

dimension	214.5mm*88.2mm*354.6mm	214.5mm*88.2mm*354.6mm
-----------	------------------------	------------------------

Model		IT8812B		IT8812C	
Rated value (0 ~ 40 °C)	Voltage	0~500V		0~120V	
	Current	0~3A	0~15A	0~6A	0~60A
	power	200W		250W	
	Min-op-V	0.6V at 3A	4.5V at 15A	0.18V at 6A	1.1V at 60A
CV mode	range	0.1~50V	0.1~500V	0.1~18V	0.1~120V
	resolution	1mV	10mV	1mV	10mV
	accuracy	$\pm(0.05\%+0.025\%FS)$	$\pm(0.05\%+0.025\%FS)$	$\pm(0.025\%+0.05\%FS)$	$\pm(0.025\%+0.05\%FS)$
CC mode	range	0~3A	0~15A	0~6A	0~60A
	resolution	0.1mA	1mA	0.1mA	1mA
	accuracy	$\pm(0.05\%+0.05\%FS)$	$\pm(0.05\%+0.05\%FS)$	$\pm(0.05\%+0.05\%FS)$	$\pm(0.05\%+0.05\%FS)$
CR mode	range	0.3Ω~10Ω	10Ω~7.5KΩ	0.05Ω~10Ω	10Ω~7.5KΩ
	resolution	16bit		16bit	
	accuracy	0.01%+0.08S	0.01%+0.0008S	0.01%+0.08S	0.01%+0.0008S
CP mode	range	200W		250W	
	resolution	10mW		10mW	
	accuracy	0.1%+0.1%FS		0.2%+0.2%FS	
Dynamic mode					
Dynamic mode		CC mode		CC mode	
	T1 & T2	20uS~3600S /Res:1 uS		20uS~3600S /Res:1 uS	
	accuracy	5uS±100ppm		5uS±100ppm	
	slew rate	0.0001~0.25A/uS	0.001~2.5A/uS	0.0001~0.25A/uS	0.001~2.5A/uS
Measurement range					
Readback voltage	range	0~50V	0~500V	0~18V	0~120V
	resolution	0.1 mV	1 mV	0.1 mV	1 mV
	accuracy	$\pm(0.025\%+0.025\%FS)$	$\pm(0.025\%+0.025\%FS)$	$\pm(0.025\%+0.025\%FS)$	$\pm(0.025\%+0.025\%FS)$
Readback current	range	0~3A	0~15A	0~6A	0~60A
	resolution	0.01mA	0.1mA	0.1mA	1mA
	accuracy	$\pm(0.05\%+0.05\%FS)$		$\pm(0.05\%+0.1\%FS)$	
Readback power*2	range	200W		250W	
	resolution	10mW		10mW	
	accuracy	$\pm(0.1\%+0.1\%FS)$		$\pm(0.2\%+0.2\%FS)$	
Protection range					
OPP		$\cong 200W$		$\cong 250W$	
OCP		$\cong 3.3A$	$\cong 16.5A$	$\cong 6.6A$	$\cong 66A$
OVP		$\cong 500V$		$\cong 120V$	
OTP		$\cong 85^{\circ}C$		$\cong 85^{\circ}C$	
specification					
Short circuit	current	$\cong 3.3/3A$	$\cong 16.5/15A$	$\cong 6.6/6A$	$\cong 66/60A$
	voltage	0V	0V	0V	0V
	resistance	$\cong 300m\Omega$	$\cong 300m\Omega$	$\cong 30m\Omega$	$\cong 30m\Omega$
Input impedance		1MΩ		300KΩ	
dimension		214.5mm*88.2mm*354.6mm		214.5mm*88.2mm*354.6mm	

4.2 Supplementary characteristic

Memory capacity:100 groups

Suggested calibration frequency: 1time/year

Cooling method: Fan cool

Fan-control temperature

Temperature	35°C	50°C	70°C	80°C
Fan status	1 scale	2 scale	3 scale	OTP.load off

Chapter5 References of Load Communication Interfaces

IT8800 series electronic load is provided with three communication interfaces to communicate with a computer for selection, including RS232, USB and GPIB.

5.1 RS232 interface

Cable connection load with both ends of COM interface (DB9) and computer. Composite key **[Shift]** + numeric key 8 on front board can be used to enter system menu for activation.

In RS-232 interface, all SCPI commands can be used for programming. If RS-232 interface is selected, in accordance with internal connection of data terminal equipment (DTE) and data communication equipment (DCE) as defined in EIA RS-232, the load is connected to another DTE (e.g., PC COM interface) with direct-connected Modem cable.



NOTE

RS-232 setting in procedure should be consistent with that in system menu of front board. Press composite key **[Shift]** + numeric key 8 to change (if necessary). Send a ^C or ^X character string to the load to pause data transmission. It will clear any uncompleted operation and waive any uncompleted output.

RS-232 data format

RS-232 data comprises start bit, odd and even parity check bit, stop bit and 8-bit data bit. Start bit and stop bit are not editable. However, next odd or even item can be selected by front board **[Shift]** + numeric key 8 (System). The odd and even items are saved in NVM.

Baud rate

Through front board **[Shift]** + numeric key 8 (System), the user may select one Baud rate saved in NVM: 4800 /9600 /19200 /38400 /57600 /115200

RS-232 Connection

Use RS-232 cable with DB-9 interface because the RS-232 serial port can be connected controller (e.g. PC) serial port. Do not use modulating cable of air-conditioner. Refer to the following table for plug pin.

If your computer is provided with a RS-232 interface with DB-25 plug, a cable and a adapter with DB-25 plug (one end) and DB-9 plug (the other end) are required (not the modulating cable of the air-conditioner).

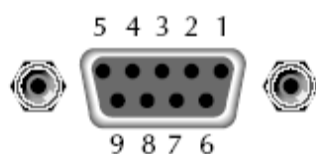

RS232 Pins of Plug

Base pin number	Description
1	No conjunction
2	TXD, data transmission
3	RXD, data receiving
4	No conjunction

5	GND, grounding
6	No conjunction
7	CTS, clear to send
8	RTS, request to send
9	No conjunction

5.2 USB Interface

Connect the load and the computer using a cable with two USB interfaces (each end). All functions of the load can be programmed via USB.

The functions of load USB488 interface are as follows:

- The interface is 488.2 USB488 Interface.
- The interface receives requests of REN_CONTROL, GO_TO_LOCAL and LOCAL_LOCKOUT.
- The interface receives the command MsgID=TRIGGER USBTMC and conveys the TRIGGER command to the functional layer.

The functions of load USB488 device are as follows:

- Capable to read all common SCPI commands.
- SR1 enabled.
- RL1 enabled.
- DT1 enabled.

5.3 GPIB interface

Firstly, connect load GPIB interface and computer GPIB card through IEEE488 bus and ensure sufficient contact. Tighten them with screws. Set address. Load address range: 0 to 31. Press **[Shift]** + numeric key 8 (System) to enter system menu functions. Press Left/Right key to find Communication. Select GPIB and set address. Input address and press **[Enter]** for confirmation. The load works by setting GPIB address on front board. GPIB address is saved in NVM.

Appendix

Specifications of Red and Black Test Lines

ITECH provides you with optional red and black test lines, which individual sales and you can select for test. For specifications of ITECH test lines and maximum current values, refer to the table below.

Model	Specification	Cross section	Length
IT-E301/10A	10A	-	1m
IT-E301/30A	30A	6mm ²	1.2m
IT-E301/30A	30A	6mm ²	2m
IT-E301/60A	60A	20mm ²	1.5m
IT-E301/120A	120A	50mm ²	2m
IT-E301/240A	240A	70mm ²	1m
IT-E301/240A	240A	70mm ²	2m
IT-E301/360A	360A	95mm ²	2m

For maximum current of AWG copper wire, refer to table below.

AWG	10	12	14	16	18	20	22	24	26	28
The Maximum current value(A)	40	25	20	13	10	7	5	3.5	2.5	1.7

Note: AWG (American Wire Gage), it means X wire (marked on the wire). The table above lists current capacity of single wire at working temperature of 30°C. For reference only.

Contact Us

Thanks for purchasing ITECH products. In case of any doubts, please contact us as follows:

1. Refer to accompanying data disk and relevant manual.
2. Visit ITECH website: www.itechate.com.
3. Select the most convenient contact method for further information.